

Standard Air-conditioners

Application program for pCO¹, pCO², pCO³, pCO^{xs}

CAREL



ENG

User manual

Manual version: 2.6 dated 11/02/2016
Program code: FLSTDMCZ0E

**LEGGI E CONSERVA
QUESTE ISTRUZIONI**
**READ AND SAVE
THESE INSTRUCTIONS**

T e c h n o l o g y & E v o l u t i o n



We wish to save you time and money!

We can assure you that the thorough reading of this manual will guarantee correct installation and safe use of the product described.

IMPORTANT WARNINGS



BEFORE INSTALLING OR HANDLING THE APPLIANCE, PLEASE CAREFULLY READ AND FOLLOW THE INSTRUCTIONS CONTAINED IN THIS MANUAL.

The appliance this software is intended for has been expressly designed to ensure safe operation, provided that:
the software is installed, programmed, used and maintained by qualified personnel in full accordance with the instructions contained in this manual;
all conditions specified and contained in the appliance installation and operating manual are met.

Any other use and modification to the appliance not expressly authorised by the manufacturer shall be considered improper.
Liability for injuries or damage caused by improper use lies exclusively with the user.

Contents

1.	Introduction.....	7
1.1	Main new features in version 2.0.....	7
1.2	Introduction and functions performed by the program.....	7
1.3	Compatible hardware.....	7
2.	The user terminal.....	8
2.1	Type and operation.....	8
2.2	LEDs.....	8
2.3	Functions of the buttons.....	9
3.	pLAN management between boards.....	11
3.1	How to assign the pLAN addresses.....	11
4.	Selecting the language.....	12
5.	Starting for the first time.....	12
6.	List of configurations.....	13
6.1	Digital inputs.....	13
6.2	Analogue inputs.....	13
6.3	Digital outputs.....	14
6.4	Analogue outputs.....	14
7.	List of parameters and default values.....	15
8.	Screens.....	26
8.1	List of the screens.....	26
9.	EVD400 electronic expansion valve.....	28
10.	Temperature control.....	29
10.1	Direct expansion units.....	29
10.2	Other temperature functions.....	30
10.3	Units with two water coils.....	30
10.4	Units with one water coil.....	30
11.	Humidity control.....	31
11.1	Direct expansion units.....	31
11.2	Units with water coils.....	32
11.3	Other humidity control functions.....	32
12.	Built-in humidifier.....	33
12.1	Setting the parameters for selecting the humidifier.....	33
12.2	Humidity and steam production control.....	34
13.	Recovery coil.....	35
13.1	Recovery without the cooling devices.....	35
13.2	Recovery with the cooling devices on, direct expansion units.....	36
13.3	Recovery with the cooling devices on, units with water coils.....	36
14.	Outlet limit.....	37
15.	Condenser fans.....	38
15.1	Single or separate coil.....	38
15.2	Number of probes.....	38
15.3	Prevent function.....	38
15.4	Speed-up function.....	39
15.5	Pressure – temperature conversion.....	39
16.	Temperature set point compensation.....	39
17.	Compressors.....	40
17.1	Capacity control.....	40
17.2	Rotation.....	40
17.3	Times.....	40
17.4	Compressor alarms.....	40
18.	Heaters.....	41
18.1	Heater alarms.....	41
19.	Modulating valves.....	42
19.1	Three point valves.....	42
19.2	0 to 10 Volt valves.....	42

20.	Outlet fan	42
21.	Manual device management	42
22.	Switching the unit on and off.....	43
	22.1 Automatic unit start-up and standby.....	43
23.	Alarms	44
	23.1 Alarm relay.....	44
	23.2 Alarm summary table.....	44
24.	Alarm log	46
	24.1 Basic log.....	46
	24.2 Advanced log	46
25.	Supervisor.....	47
	25.1 Variable database.....	47
26.	Glossary	51

1. Introduction

1.1 Main new features in version 2.0

New functions:

1. Implemented compatibility with pCO³;
2. Implemented management of the EVD400.

1.2 Units with water coils

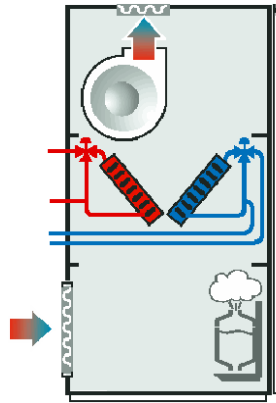

Direct expansion units

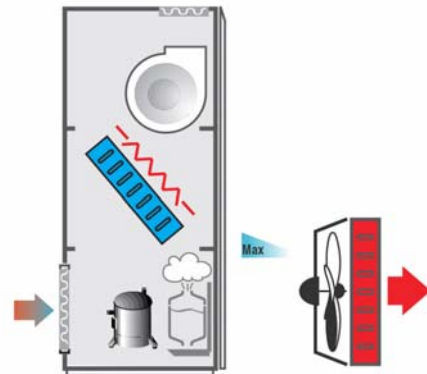

1.3 Introduction and functions performed by the program

The "Standard air-conditioners" program can be used with CAREL pCO¹ (small-medium), pCO^{XS}, pCO² (small-medium) or pCO³ (small-medium) boards, and manages direct expansion air-conditioning units (ED) or units with water coils (CW).

The main functions of the program are:

- management of the temperature and the humidity in civil or technological environments;
- management of 1 or 2 hermetic or semi-hermetic compressors;
- management of 1 or 2 electric heaters (including with binary management, up to 3 heating steps);
- modulating heating valves, 0 to 10 Volt and 3 point;
- modulating cooling valves, 0 to 10 Volt and 3 point;
- external or built-in CAREL immersed electrode humidifier;
- ON/OFF or modulating condenser fans, controlled by pressure or temperature;
- outlet temperature control;
- alarm management, alarm log, device timers, signals;
- complete management of the device timers;
- connection to local supervision networks and BMS (LonWorks, BACnet, Modbus...).

The terminal with LCD can be used to display and modify the following data at any time:

- readings and calibration of the probes connected;
- unit ON/OFF;
- alarm detection;
- programming of the configuration parameters and the operating parameters with password-protected access;
- operating hours of the controlled devices and time bands with password-protected access;
- programming of the clock and the time bands with password-protected access;
- choice between different languages (English, Italian, German, French).

In addition, the following functions can be managed via a CAREL pLAN connection:

1. balancing of operating hours between the air-conditioners by rotation of the spare unit (standby)
2. activation of the spare unit if another unit is shutdown due to a serious alarm or blackout
3. activation of the spare unit to compensate for excessive thermal load
4. control of up to 8 air-conditioners with just one external LCD terminal
5. operation of all the air-conditioners based on the probe readings on the Master, to harmonise the overall action
6. management of alarm printouts and probe readings using a shared external terminal

WARNING: to avoid tampering during operation, only qualified personnel must know the password.

1.4 Compatible hardware

The program is compatible with the following devices:

- pCO^{XS}, codes PCO100*;
- pCO¹, pCO², pCO³ SMALL and MEDIUM;
- PCOT* 4x20 LCD for panel installation and wall mounting;
- PCOI* 4x20 LCD for panel installation;
- PGDO* semi-graphic display;
- built-in LCD on the pCO^{XS} and pCO², pCO³ boards.

2. The user terminal

2.1 Type and operation

Three types of terminal are envisaged:

1. PGD0/semi-graphic/6 buttons/4 rows - 20 columns/connection with telephone cable
2. LCD/15 buttons/4 rows - 20 columns/connection with telephone cable
3. Built-in/6 buttons/4 rows - 20 columns (pCO²- pCO³ only)/display on board

The user terminal can be used to perform all the operations allowed by the program, display the operating conditions of the unit at all times, and set the parameters.

It can be disconnected from the main board, and in fact is not required for operation.

2.2 LEDs

2.2.1 PGD0 terminal with 6 buttons

LED	Colour	Description
 button (Alarm)	Red	On – One or more active alarm conditions
Prg button	Yellow	On – Unit on Flashing – Unit off from supervisor or digital input

All the LEDs not described and located underneath the remaining 4 buttons indicate the correct power supply to the instrument. Together with the backlighting on the display, these will be switched off if no button is pressed on the keypad for 5 minutes.

2.2.2 LCD terminal with 15 buttons

Each button has a green LED indicating the specific group of parameters selected during the operations to display/modify the operating parameters. The silicone rubber buttons have three different coloured LEDs, whose meaning is specified in the following table

LED	Colour	Description
[On/Off] button	Green	On – Unit on Flashing – Unit off from supervisor or digital input
[Alarm] button	Red	On – One or more active alarm conditions
[Enter] button	Yellow	On – Instrument correctly powered

2.2.3 Built-in terminal with 6 buttons

Given the number of buttons and LEDs available, these have general meanings, as described below:

LED	Colour	Description
 button (Alarm)	Red	On – One or more active alarm conditions
[↵] button (Enter)	Yellow	On – Unit on Flashing – Unit off from supervisor or digital input
[Prg] button	Green	On – Displaying/modifying the operating parameters
[Esc] button	Green	On – Main menu parameters displayed

2.3 Functions of the buttons



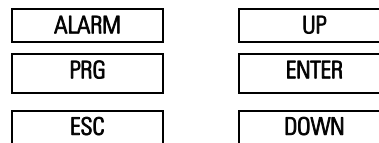
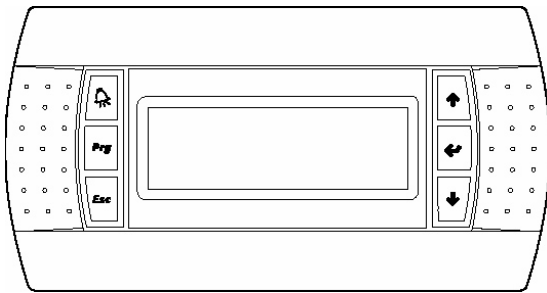



2.3.1 PGD0 terminal with 6 buttons







Button	Description
ALARM	displays the alarms, mutes the buzzer and deletes the active alarms
UP	if the cursor is in the home position (top left corner), scrolls up the screens in the same group; if the cursor is in a setting field, increases the value
DOWN	if the cursor is in the home position (top left corner), scrolls down the screens in the same group; if the cursor is in a setting field, decreases the value
ENTER	used to move the cursor from the home position (top left corner) to the setting fields, in the setting fields confirms the set value and moves to the next parameter
PRG	accesses the menu for selecting the group of parameters to be displayed/modified (access to the parameters is confirmed by pressing the [Enter] button)
PRG + ENTER	temporarily display the pLAN serial address of the board

2.3.2 PGD0 terminal with 15 buttons



Button	Description
 MENU	From any point of the user interface (with the exception of the manufacturer group of parameters) returns to the Main menu screen (M0) displaying the unit status, readings of the control probes and operating mode. In the group of manufacturer parameters, organised into nested sub-groups, returns to screen for selecting the parameters.
 MAINTENANCE	Goes to the first screen of Maintenance parameters (A0) The Maintenance parameters are used to check the operating status of devices and the probes, calibrate the readings and run manual operations
 PRINTER	Goes to the printer menu (H1)
 INPUTS AND OUTPUTS	Goes to the first screen of I/O parameters (I0) The I/O parameters display the status of the inputs and the outputs on the board
 CLOCK	Goes to the first screen of Clock parameters (K0) The Clock parameters are used to display/set the operating parameters for the clock board and activate the time bands
 SET POINT	Goes to the first screen of Set point parameters (S0). The Set point parameters are used to display/modify the unit working set point within the limits defined in the configuration
 PROGRAM	Goes to the screen for entering the user password (P0) The user parameters are used to modify the unit operating mode

Button		Description
	MENU + PROG	Goes to the screen for entering the manufacturer password (Z0) The manufacturer parameters are used to configure the unit in terms of the number and type of devices connected, enable specific accessories or special functions
	INFO	In pLAN applications with more than one board connected in the network and a shared user terminal, switches the user terminal between the different units to display/modify the parameters
	RED	Temporary display of the pLAN address of the current board
	BLUE	From printer management screen H1, starts printing screens C0 to Ca

Silicone rubber buttons



Button	Description
1 ON/OFF	switches the unit on/off
2 ALARM	displays the alarms, mutes the buzzer and deletes the active alarms
3 UP ARROW	if the cursor is in the home position (top left corner), scrolls up the screens in the same group; if the cursor is in a setting field, increases the value
4 DOWN ARROW	if the cursor is in the home position (top left corner), scrolls down the screens in the same group; if the cursor is in a setting field, decreases the value
5 ENTER	used to move the cursor from the home position (top left corner) to the setting fields, in the setting fields confirms the set value and moves to the next parameter

2.3.3 Built-in terminal with 6 buttons



ALARM	PRG	ESC
-------	-----	-----

DOWN	UP	ENTER
------	----	-------

Button	Description
ALARM	displays the alarms, mutes the buzzer and deletes the active alarms
UP	if the cursor is in the home position (top left corner), scrolls up the screens in the same group; if the cursor is in a setting field, increases the value
DOWN	if the cursor is in the home position (top left corner), scrolls down the screens in the same group; if the cursor is in a setting field, decreases the value
ENTER	used to move the cursor from the home position (top left corner) to the setting fields, in the setting fields confirms the set value and moves to the next parameter
PRG	accesses the menu for selecting the group of parameters to be displayed/modified (access to the parameters is confirmed by pressing the [Enter] button)
PRG + ENTER	temporary display of the board pLAN serial address

3. pLAN management between boards

The pLAN network identifies a physical connection between the boards (pCO¹, pCO², pCO³) and the external terminals. pLAN = .CO L.ocal A.rea N.etwork.

The purpose of the pLAN network connection between the boards is to exchange variables, according to the logic decided by the program, so as the units can operate together. The variables exchanged between the boards are established by the program, as is the direction of exchange, and therefore there are no user settings; the only operation required by the user involves the electrical connections.

Below is a diagram with all the components connected in the pLAN:

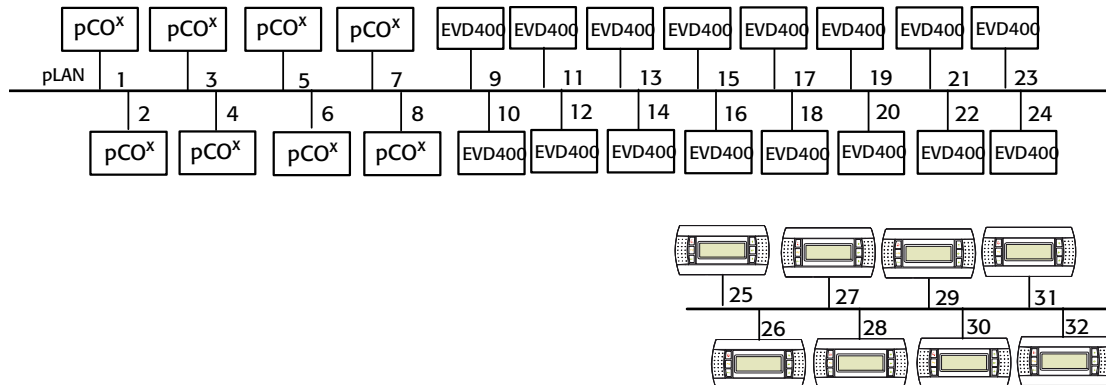

	pCO	EVD400 cool	EVD400 heat
UNIT 1	1	9	10
UNIT 2	2	11	12
UNIT 3	3	13	14
UNIT 4	4	15	16
UNIT 5	5	17	18
UNIT 6	6	19	20
UNIT 7	7	21	22
UNIT 8	8	23	24

Below is a diagram with the EVD400 driver in a tLAN connection, while the others components are connected in the pLAN:

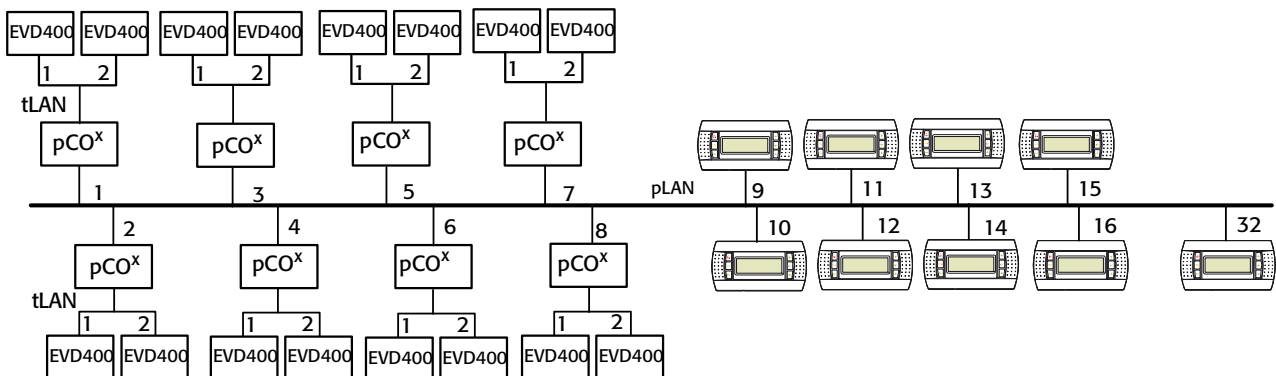

3.1 How to assign the pLAN addresses

The pLAN addresses must be unique and follow the layout shown above. There are various different ways to assign the pLAN address

3.1.1 PGD0 terminal

To set the address of a PGD terminal (the default value is 32), proceed as follows:

1. Power up the terminal
2. Press the Up + Down + ENTER buttons until the "display address setting" screen is displayed
3. Enter the numeric pLAN address with the Up and Down buttons and then confirm by pressing Enter
4. The "No link" screen will be displayed
5. If the "No Link" screen is not displayed, press Up + Down + ENTER again
6. Once the "display address setting" screen is displayed, press Enter 3 times

When the "adr Priv/shard" screen is displayed, set the correct values and confirm with "YES"

3.1.2 Setting the address on the pCO¹- pCO³

Operations required to set the pLAN address on the pCO¹ and pCO³ boards.

1. Power down the pCO* board and connect a 4x20 LCD terminal / PGD0 terminal with pLAN address "0".
2. Power up the pCO* board, by holding the Alarm + Up buttons until the "pLAN Address" screen appears.
3. When the "pLAN Address" screen is shown, follow the operations shown, i.e. enter the number (1,2,3...) of the pLAN address with the Up and Down buttons and then confirm by pressing Enter.
4. Power down the pCO* board.
5. If necessary, assign the correct pLAN address to the external terminal according to the specific system configuration.
6. Power up the pCO* board.
7. Configure the pCO* to communicate speak with the terminal, if necessary.

3.1.3 Setting the address on the pCO², PCOI/PCOT terminals

The pLAN addresses on these units are set with binary logic by changing the position of a set of dipswitches located on the rear of the pCOI / PCOT terminals and on the pCO² boards. This must be done with all the devices off. For further information, see the specific manual for the device.

3.1.4 Setting the address on the EVD400

To set the address of the EVD400 in both pLAN and tLAN, see the EVD400 manual (code +030220225).

In all the screens in the program, to display the address of the board that is currently connected, press the printer button or Enter+Prg, depending on the terminal used.

4. Selecting the language

When the unit is switched on, by default a screen is displayed for selecting the language.

This screen is displayed for 30 seconds, after which the application automatically opens the main menu (screen M0).

The language automatically loaded is English, however this can be selected from the following options: English, Italian, French, German. To modify the language, proceed as follows:

1. press the maintenance button on the external terminal, while on the Built-in terminal or the external PGD0* terminal press the Prg button and confirm the first item in the MAINTENANCE menu by pressing the Enter button;
2. the software presentation screen will be displayed, showing the code, the version and the date. Press the Enter button to move the cursor to the last row;
3. select the desired language using the Up or Down buttons;
4. press the Enter button to confirm.

5. Starting for the first time

After having checked the connections between the various boards and terminals, power up the pCO* board/boards. On power-up, the software automatically installs the default values chosen by CAREL for the unit configuration parameters. This section explains how to restore the default values and to return to the starting conditions. When starting for the first time, this operation is not required.

The following procedure is used to restore all the configuration parameters to the default values selected by CAREL.

CAUTION! this procedure irreversibly deletes any programming performed by the user.

As resetting the default values is an operation that involves each pCO* board, when more than one board is present, the procedure must be repeated for the all the boards. The procedure is identical for all the boards. Proceed as follows:

- press the "menu" and "prog" buttons on the LCD terminal at the same time (go to the manufacturer branch on the PGD0 terminal). When pressed, the LEDs corresponding to the "menu" and "prog" buttons will come on;
- enter the password using the "arrow" buttons and press Enter: this enters the "manufacturer" configuration branch:

```
+-----+
|Manufacturer
|Password
|
|                                0000
|
+-----+
```

- enter the "Initialisation" branch:

```
+-----+
|Insert password  V0|
|to install
|default value
|Operation done
|
+-----+
```

- move the cursor to the password setting field, enter 1234 and confirm by pressing Enter. At the end of the operation, the message "Operation completed" is displayed.

6. List of configurations

Both direct expansion (ED) and water coil (CW) air-conditioners can be managed, with pCO¹/pCO²/pCO^{XS}/pCO³ small/medium boards. On power-up, the program recognises the type and the size of board, and consequently arranges the inputs and outputs, based on the type of air-conditioner (ED or CW) defined in the manufacturer branch. The following diagrams indicate the configuration of the inputs and outputs in the possible combinations. The multiple items (xxx / xxx / ...) indicate different possible uses for an input or output; the choice is made using the parameters in the Manufacturer branch of screens. For the wiring, refer to the technical manual on the pCO boards.

6.1 Digital inputs

Direct expansion air-conditioners (ED)

No.	pCO ¹ - pCO ² - pCO ³ SMALL	pCO ¹ - pCO ² - pCO ³ MEDIUM	pCO ^{XS}
ID 1	Alarm C1/Low pressure C1	Alarm C 1	Low pressure C1
ID 2	Alarm C2/High pressure C1	Alarm C2	High pressure C1
ID 3	Heater 1 overload alarm	Heater 1 overload alarm	Heater thermal overload
ID 4	Heater 2 overload alarm	Heater 2 overload alarm	Fan thermal overload
ID 5	Fire / filter / Flood alarm	Dirty filter alarm	Air flow alarm
ID 6	Fan thermal overload alarm	Fan thermal overload alarm	Remote ON/OFF
ID 7	Air flow switch alarm	Air flow switch alarm	---
ID 8	Remote ON/OFF	Remote ON/OFF	---
ID 9	---	Low pressure alarm C1	---
ID 10	---	Low pressure alarm C2	---
ID 11	---	Humidifier water level	---
ID 12	---	Fire / Flood alarm	---
ID 13	---	Thermal overload alarm, cond. fan C1	---
ID 14	---	Thermal overload alarm, cond. fan C2	---

Water-source air-conditioners

No.	pCO ¹ - pCO ² - pCO ³ SMALL	pCO ¹ - pCO ² - pCO ³ MEDIUM	pCO ^{XS}
ID 1	Flood / fire alarm	Flood alarm	Flood alarm
ID 2	Cooling - heating selection	Cooling - heating selection	Smoke / fire alarm
ID 3	Heater 1 overload alarm	Heater 1 overload alarm	Heater thermal overload
ID 4	Heater 2 overload alarm	Heater 2 overload alarm	Fan thermal overload
ID 5	Dirty filter alarm	Dirty filter alarm	Air flow alarm
ID 6	Fan thermal overload alarm	Fan thermal overload alarm	Remote ON/OFF
ID 7	Air flow switch alarm	Air flow switch alarm	---
ID 8	Remote ON/OFF	Remote ON/OFF	---
ID 9	---	Auxiliary alarm	---
ID 10	---	Water flow switch alarm	---
ID 11	---	Humidifier water level	---
ID 12	---	Fire alarm	---
ID 13	---	---	---
ID 14	---	---	---

6.2 Analogue inputs

Direct expansion air-conditioners (ED)

No.	pCO ¹ - pCO ² - pCO ³ SMALL	pCO ¹ - pCO ² - pCO ³ MEDIUM	pCO ^{XS}
B 1	Ambient humidity	Ambient humidity	Ambient humidity / Outside temperature / Recovery temperature
B 2	High press. C1 / Cond. temp. C1 / Outlet temperature (pCO ² pCO ³)	High press. C1 / Cond. temp. C1	High pressure C1
B 3	High pressure C2 / Cond. temp. C2 / Recovery temperature	High pressure C2 / Cond. temp. C2 / Recovery temperature (pCO ² pCO ³), Humidifier conductivity (pCO ¹)	Outlet temperature
B 4	Outside temperature	Outside temperature (pCO ² pCO ³) Humidifier current (pCO ¹)	Room temperature
B 5	Room temperature	Room temperature	---
B 6	Outlet temperature (pCO ¹)	Outlet temperature	---
B 7	---	Humidifier conductivity (pCO ² pCO ³) Recovery temperature (pCO ¹)	---
B 8	---	Humidifier current (pCO ² pCO ³) Outside air temperature (pCO ¹)	---

Water-source air-conditioners

No.	pCO ¹ - pCO ² - pCO ³ SMALL	pCO ¹ - pCO ² - pCO ³ MEDIUM	pCO ^{XS}
B 1	Ambient humidity	Ambient humidity	Ambient humidity
B 2	Outlet temperature	Outlet temperature	Outside air temperature / Recovery temperature
B 3	Recovery temperature	Recovery temperature (pCO ² pCO ³) / Humidifier conductivity (pCO ¹)	Outlet temperature
B 4	Outside temperature	Outside temperature (pCO ² pCO ³) / Humidifier current (pCO ¹)	Room temperature
B 5	Room temperature	Room temperature	---
B 6	FREE	FREE	---
B 7	---	Humidifier conductivity (pCO ² pCO ³) / Recovery temperature (pCO ¹)	---
B 8	---	Humidifier current (pCO ² pCO ³) / Outside temperature (pCO ¹)	---

6.3 Digital outputs

Direct expansion air-conditioners (ED)

No.	pCO ¹ - pCO ² - pCO ³ SMALL	pCO ¹ - pCO ² - pCO ³ MEDIUM	pCO ^{XS}
DO 1	Outlet fan	Outlet fan	Outlet fan
DO 2	Compressor 1	Compressor 1	Compressor 1
DO 3	Compressor 2	Compressor 2	Heater 1
DO 4	Heater 1 / Open heating valve	Heater 1 / Open heating valve	Dehumidification
DO 5	Heater 2 / Close heating valve	Heater 2 / Close heating valve	General alarm
DO 6	Dehumidification	Dehumidification	---
DO 7	Recovery	Recovery / minor alarms	---
DO 8	General alarms	Serious alarms	---
DO 9	---	Cond. fanC1 / Cap. control C 1	---
DO 10	---	Cond. fanC2 / Cap. control C 2	---
DO 11	---	Humidification	---
DO 12	---	Fill water in humidifier	---
DO 13	---	Empty water in humidifier	---

Water-source air-conditioners

No.	pCO ¹ - pCO ² - pCO ³ SMALL	pCO ¹ - pCO ² - pCO ³ MEDIUM	pCO ^{XS}
DO 1	Outlet fan	Outlet fan	Outlet fan
DO 2	Open cooling / single valve	Open cooling / single valve	Open cooling valve
DO 3	Close cooling / single valve	Close cooling / single valve	Close cooling valve
DO 4	Heater 1 / Open heating valve	Heater 1 / Open heating valve	Heater
DO 5	Heater 2 / Close heating valve	Heater 2 / Close heating valve	General alarm
DO 6	Dehumidification	Dehumidification	---
DO 7	Recovery	Recovery / minor alarms	---
DO 8	General alarms	Serious alarms	---
DO 9	---	---	---
DO 10	---	---	---
DO 11	---	Humidification	---
DO 12	---	Fill water in humidifier	---
DO 13	---	Empty water in humidifier	---

6.4 Analogue outputs

Direct expansion air-conditioners (ED)

No.	pCO ¹ - pCO ² - pCO ³ SMALL	pCO ¹ - pCO ² - pCO ³ MEDIUM	pCO ^{XS}
AO 1	Outlet fan / Recovery valve	Outlet fan / Recovery valve	Humidifier / Recovery valve
AO 2	Heating valve / Humidification	Heating valve / Humidification	Heating valve
AO 3	Condenser fan 1	Condenser fan 1	Condenser fan 1
AO 4	Condenser fan 2	Condenser fan 2	---

Water-source air-conditioners

No.	pCO ¹ - pCO ² - pCO ³ SMALL	pCO ¹ - pCO ² - pCO ³ MEDIUM	pCO ^{XS}
AO 1	Cooling valve / single valve	Cooling valve / single valve	Humidifier
AO 2	Heating valve / Recovery valve / Humidification	Heating valve / Recovery valve / Humidification	Heating valve
AO 3	---	---	Recovery valve
AO 4	Outlet fan	Outlet fan	---

7. List of parameters and default values

The following table describes the parameters in the program, with the following information: screen code (the screen code is shown at the top right) to help identify the parameter, default value, minimum and maximum limits for the settings (range), unit of measure, free column for entering the desired value. To find a parameter on the display, proceed as follows:

- Identify the parameter in the following table and the code of the corresponding screen
- From the list of screens (following paragraph) and the screen code, scroll to the screen on the terminal.

Parameter	Type	Ref.	Description	UOM	Range	Default	Notes
MAIN SCREEN			15-button terminal MENU button		6-button PGD0* or Built-in terminal ESC button		
Temperature	R	M0	Room temperature	°C/F			
Humidity	R	M0	Ambient humidity	% RH			
Cooling	R	M1	Operating mode		N/Y		
Heating	R	M1	Operating mode		N/Y		
Humidif.	R	M1	Operating mode		N/Y		
Deumidif.	R	M1	Operating mode		N/Y		
Supply Air limit	R	M2	Outlet temperature limit status		N/Y		
Dehumidif. limit	R	M2	Dehumidification limit status		N/Y		
Function.:	R	M2	Current operating mode		Cooling/Heating		
Unit status	R	M3	With the Built-In terminal this variable describes the current unit operating status. (1.Unit ON, 2.OFF from alarm, 3.OFF from superv., 4.OFF from band, 5.OFF from Remote In., 6.OFF from button, 7.Manual Proc., 8.Standby)		1 to 8		
- Press ENTER to -	R	M3	Pressing the ENTER button switches the unit on or OFF		Switch on/off		
CLOCK			15-button terminal CLOCK button		6-button PGD0* or Built-in terminal PRG button and CLOCK in the menu		
Regulation clock Hour	R/W	K0	Hour setting	Hours	0 to 23	current hour	
Hour	R/W	K0	Minute setting	minutes	0 to 59	current minutes	
Date	R/W	K0	Day setting		1 to 31	current day	
Date	R/W	K0	Month setting		1 to 12	current month	
Date	R/W	K0	Year setting		0 to 99	current year	
Day	R	K0	Current day of the week (Monday, Tuesday, Wednesday,.....)		0 to 7	current weekday	
Clock password	R/W	K1	Enter Clock password		0 to 9999	1234	
On-off timezones Temp.timezones Humid.timezones	R/W	K2	Enable temperature / humidity / ON/OFF time bands		No/Yes	No	
On-off timezones F1-1 F1-2	R/W	K3	Start and end hour for the ON/OFF time bands F1-1 and F1-2		0 to 23	9/13/14/2 1	
On-off timezones F1-1 F1-2	R/W	K3	Start and end minutes for the ON/OFF time bands F1-1 and F1-2		0 to 59	0/0/0/0	
On-off timezones F2	R/W	K4	Start and end hour for the ON/OFF time band F2		0 to 23	14/21	
On-off timezones F2	R/W	K4	Start and end minutes for the ON/OFF time band F2		0 to 59	0/0	
On-off timezones Mon: Thu: .. Sun:	R/W	K5	Select ON/OFF time bands (F1,F2,F3,F4) for each day		F1 to F4	F2	
Temp.setpoint ON Z1: Z2:	R/W	K6	Start hour for temperature bands 1 and 2		0 to 23	0/6	
Temp.setpoint ON Z1: Z2:	R/W	K6	Start minutes for temperature bands 1 and 2		0 to 59	0/0	
SET	R/W	K6	Set point for temperature time bands 1 and 2		see P1	23.0	
Temp.setpoint ON Z3: Z4:	R/W	K7	Start hour for temperature bands 3 and 4		0 to 23	12/18	
Temp.setpoint	R/W	K7	Start minutes for temperature bands 3 and 4		0 to 59	0/0	

Parameter	Type	Ref.	Description	UOM	Range	Default	Notes
ON Z3: Z4:							
SET	R/W	K7	Set point for temperature time bands 3 and 4		see P1	23.0	
Humidity setpoint ON Z1: Z2:	R/W	K8	Start hour for humidity bands 1 and 2		0 to 23	0/6	
Humidity setpoint ON Z1: Z2:	R/W	K8	Start minutes for humidity bands 1 and 2		0 to 59	0/0	
SET	R/W	K8	Set point for humidity time bands 1 and 2		see P2	23.0	
Humidity setpoint ON Z3: Z4:	R/W	K9	Start hour for humidity bands 3 and 4		0 to 23	12/18	
Humidity setpoint ON Z3: Z4:	R/W	K9	Start minutes for humidity bands 3 and 4		0 to 59	0/0	
SET	R/W	K9	Set point for humidity time bands 3 and 4		see P2	23.0	
New clock password:	R/W	Ka	Enter new Clock password		0 to 9999	1234	
INPUTS/OUTPUTS		15-button terminal INPUTS/OUTPUTS button		6-button PGD0* or Built-in terminal PRG button and INPUTS/OUTPUTS in the menu			
Analog inputs: Pr1	R	I0	Pressure probe circuit 1 (also displays the corresponding temperature value)	Bar	Screen C9		
Pr2	R	I0	Pressure probe circuit 2 (also displays the corresponding temperature value)	Bar	Screen Ca		
Amb.humidity	R	I0	Ambient humidity probe	%	Screen Cc		
Analog inputs: Room temp.	R	I1	Room temperature probe	°C/F	-30T80 °C		
Supply air	R	I1	Outlet temperature probe	°C/F	-30T80 °C		
Extern.temp.	R	I1	Outside temperature probe	°C/F	-30T80 °C		
Analog inputs: Recovery	R	I2	Recovery probe	°C/F	-30T80 °C		
Temp.cond.1	R	I2	Condensing temperature probe circuit 1	°C/F	-30T80 °C		
Temp.cond.2	R	I2	Condensing temperature probe circuit 2	°C/F	-30T80 °C		
Dig.inputs 1-3:	R	I3	Status of digital input 1 (C) = closed (A) = open				
Dig.inputs 1-3:	R	I3	Status of digital input 2 (C) = closed (A) = open				
Dig.inputs 1-3:	R	I3	Status of digital input 3 (C) = closed (A) = open				
Dig.inputs 4-6:	R	I4	Status of digital input 4 (C) = closed (A) = open				
Dig.inputs 4-6:	R	I4	Status of digital input 5 (C) = closed (A) = open				
Dig.inputs 4-6:	R	I4	Status of digital input 6 (C) = closed (A) = open				
Dig.inputs 7-8:	R	I5	Status of digital input 7 (C) = closed (A) = open				
Dig.inputs 7-8:	R	I5	Status of digital input 8 (C) = closed (A) = open				
Dig.inputs 9-11:	R	I6	Status of digital input 9 (C) = closed (A) = open				
Dig.inputs 9-11:	R	I6	Status of digital input 10 (C) = closed (A) = open				
Dig.inputs 9-11:	R	I6	Status of digital input 11 (C) = closed (A) = open				
Dig.inputs 12:	R	I7	Status of digital input 12				

Parameter	Type	Ref.	Description	UOM	Range	Default	Notes
			(C) = closed (A) = open				
Dig.inputs 12:	R	l7	Status of digital input 13 (C) = closed (A) = open				
Dig.inputs 12:	R	l7	Status of digital input 14 (C) = closed (A) = open				
analog.output:	R	l8	Status of analogue output (cooling valve, single valve)	Volt	0 to 10		
analog.output:	R	l8	Status of analogue output (heating valve)	Volt	0 to 10		
analog.output: Cond.fan 1	R	l9	Status of analogue output for condenser fan 1	Volt	0 to 10		
Cond.fan 2	R	l9	Status of analogue output for condenser fan 2	Volt	0 to 10		
analog.output: humidifier	R	la	Status of analogue output for humidifier	Volt	0 to 10		
Main fan	R	la	Status of analogue output for main fan	Volt	0 to 10		
Recovery	R	la	Status of analogue output for recovery	Volt	0 to 10		
Dig.outputs 1-3:	R	lb	Status of digital output 1		OFF/ON		
Dig.outputs 1-3:	R	lb	Status of digital output 2		OFF/ON		
Dig.outputs 1-3:	R	lb	Status of digital output 3		OFF/ON		
Dig.outputs 4-6:	R	lc	Status of digital output 4		OFF/ON		
Dig.outputs 4-6:	R	lc	Status of digital output 5		OFF/ON		
Dig.outputs 4-6:	R	lc	Status of digital output 6		OFF/ON		
Dig.outputs 7-8:	R	ld	Status of digital output 7		OFF/ON		
Dig.outputs 7-8:	R	ld	Status of digital output 8		OFF/ON		
Dig.outputs 9-11:	R	le	Status of digital output 9		OFF/ON		
Dig.outputs 9-11:	R	le	Status of digital output 10		OFF/ON		
Dig.outputs 9-11:	R	le	Status of digital output 11		OFF/ON		
Dig.outp.12-14:	R	lf	Status of digital output 12		OFF/ON		
Dig.outp.12-14:	R	lf	Status of digital output 13		OFF/ON		
Current total steam flow:	R	lg	Current total steam flow-rate	kg/h, lb/hr			
Conduct.	R	lg	Conductivity value	uS/cm			
Nominal Value Nom.Prod:	R	lh	Rated humidity production	kg/h, lb/hr			
Nom.Current:	R	lh	Rated current value	A			
Voltage:	R	lh	Rated voltage value	V			
Cylinder 1 Status:	R	li	Operating status of the cylinder (OFF, Softstart, Softstart, Stable operation, Low Prod, Stable operation, Wash)				
Activity:	R	li	Cylinder activity in progress (Cylinder OFF, Fill, Evaporation, Drain, Drain, Drain, Alarm, Drain for inact., Pre-wash, Total drain, Alarm, Check Water Fill, Period drain)				
Amps:	R	li	Current	A			
Cyl.1-Cont.	R	lj	Contact status cylinder 1		OFF/ON		
Cyl.1-Fill	R	lj	Fill status cylinder 1		OFF/ON		
Cyl.1-Drain	R	lj	Drain status cylinder 1		OFF/ON		
Water level	R	lj	Water level cylinder 1		OFF/ON		
Driver 1 EEV	R	lk	Operating mode of the driver in circuit 1 (automatic – manual)		AUTO/MAN	AUTO	
Valve Position	R	lk	Position of the electronic valve in circuit 1	Steps	0 to 100%		
Power request	R	lk	Capacity required by circuit 1	%	0 to 100%		
Driver 1 SuperHeat	R	ll	Superheating value circuit 1	°C			
Evap.Temp.	R	ll	Evaporation temperature circuit 1	°C			
Suct.Temp	R	ll	Suction temperature circuit 1	°C			
Driver 1 Evap.Press.	R	lm	Evaporation pressure circuit 1	Bar			
Evap.Temp.	R	lm	Evaporation temperature circuit 1	°C			
Cond.Press.	R	lm	Condensing temperature circuit 1	°C			
Driver 2 EVV	R	ln	Operating mode of the driver in circuit 2 (automatic – manual)		AUTO/MAN	AUTO	
Valve Position	R	ln	Position of the electronic valve in circuit 2	Steps			
Power request	R	ln	Capacity required by circuit 2	%	0 to 100%		
Driver 2 superheat	R	lo	Superheating value circuit 2	°C			
Evap.Temp.	R	lo	Evaporation temperature circuit 2	°C			
Suct.Temp	R	lo	Suction temperature circuit 2	°C			

Parameter	Type	Ref.	Description	UOM	Range	Default	Notes
Driver 2 Evap.Press.	R	lp	Evaporation pressure circuit 2	Bar			
Evap.Temp.	R	lp	Evaporation temperature circuit 2	°C			
Cond.Press.	R	lp	Condensing temperature circuit 2	°C			
Firmware version Driver 1	R	lq	Firmware version driver 1				
Driver 2	R	lq	Firmware version driver 2				
"External modem" "GSM modem"	R	lv	Type of modem used				
Status:	R	lv	Operating status of the modem (Standby, Initialisation, Searching for GSM network, Standby, Alarm, Init. error., PIN enabled error, GSM network not found, SMS saturation, Send SMS..., Connection..., Calling)		1 to 12		
Field	R	lv	Signal reception strength of the modem	%	0 to 100%		
Time next call	R	lv	Time between two successive calls				
P.ERROR	R	lv	Display presence of permanent error ON GSM modem				
Dialling number:	R	lv	Display number called				
SET POINT		15-button terminal SET POINT button		6-button PGD0* or Built-in terminal PRG button and SET POINT in the menu			
Actual Setpoints: Temperature	R	S0	Current temperature set point	°C/°F			
Humidity	R	S0	Current humidity set point	% RH			
Setpoint: Temperature	R/W	S1	Temperature set point	°C/°F	see P1	23.0	
Humidity	R/W	S1	Humidity set point	% RH	see P2	50.0	
MAINTENANCE		15-button terminal MAINTENANCE button		6-button PGD0* or Built-in terminal PRG button and MAINTENANCE in the menu			
FLSTDmCZ0E Ver.:	R	A0	Display version and date of the software				
Language:	R/W	A0	Current language of the user interface		English, Italian, French, German	English	
System informat. Bios:	R	A1	Display the version and date of the bios				
Boot:	R	A1	Display the version and date of the boot				
Running hours: Main fan	R	A2	Display operating hours of the main fan				
Humidifier	R	A2	Display humidifier operating hours				
Running hours: Compressor1	R	A3	Display operating hours of compressor 1				
Compressor2	R	A3	Display operating hours of compressor 2				
Maintenance Password	R/W	A5	Enter password		0 to 9999	1234	
Modify runn hours Compressor1	R/W	A6	Modify compressor 1 operating hours	hours	0 to 99 0 to 999	0	
Compressor2	R/W	A6	Modify Compressor 2 operating hours	hours	0 to 99 0 to 999	0	
Modify runn hours ventilatore	R/W	An	Modify outlet fan operating hours	hours	0 to 99 0 to 999	0	
Humidifier hour reset	R/W	An	Reset humidifier operating hours		No/Yes		
Threshold running hours alarm (x1000)	R/W	A7	Operating hour threshold of the devices	hours x 1000	0 to 99 0 to 999	99	
Probes Setting Pressure 1	R/W	A8	Condensing pressure probe 1 calibration	% RH	-9.9 to 9.9	0	
Pressure 2	R/W	A8	Condensing pressure probe 2 calibration	bar	-9.9 to 9.9	0	
Humidity	R/W	A8	Humidity probe calibration	bar	-9.9 to 9.9	0	
Ambient temp.	R/W	A9	Room temperature probe calibration	°C / °F	-9.9T9.9	0	
Extern.temp.	R/W	A9	Outside temperature probe calibration	°C / °F	-9.9T9.9	0	
Supply Air	R/W	A9	Outlet temperature probe calibration	°C / °F	-9.9T9.9	0	
Temp.recup.	R/W	Aa	Recovery probe calibration	°C / °F	-9.9T9.9	0	
Temp.cond.1	R/W	Aa	Cond. temperature probe 1 calibration	°C / °F	-9.9T9.9	0	
Temp.cond.2	R/W	Aa	Cond. temperature probe 2 calibration	°C / °F	-9.9T9.9	0	
Manual Procedure Dout 01 Dout 02 Dout 03	R/W	Ab	Manual activation of digital outputs 1 – 2 – 3		OFF/ON	OFF	
Manual Procedure Dout 04 Dout 05	R/W	Ac	Manual activation of digital outputs 4 – 6		OFF/ON	OFF	

Parameter	Type	Ref.	Description	UOM	Range	Default	Notes
Manual Procedure Dout 06 Dout 07 Dout 08	R/W	Ad	Manual activation of digital outputs 7 – 8		OFF/ON	OFF	
Manual Procedure Dout 09 Dout 10	R/W	Ae	Manual activation of digital outputs 9 – 10		OFF/ON	OFF	
Manual Procedure Dout 11 Dout 12 Dout 13	R/W	Ao	Manual activation of digital outputs 11 – 12 – 13		OFF/ON	OFF	
Manual Procedure Aout 01 Aout 02	R/W	Af	Set the operating mode of modulating outputs 1 – 2		AUTO/MAN	AUTO	
Manual Procedure Aout 01 Aout 02	R/W	Af	Manual activation of modulating outputs 1 – 2	Volt	0 to 10.0	0	
Manual Procedure Aout 03 Aout 04	R/W	Ag	Set the operating mode of analogue outputs 3 – 4		AUTO/MAN	AUTO	
Manual Procedure Aout 03 Aout 04	R/W	Ag	Manual activation of modulating outputs 3 – 4	Volt	0 to 10.0	0	
Integr.humidifier Pre-clean	R/W	Ah	Activation of pre-wash for built-in humidifier (not pCO ^{ss})		No/Yes	No	
Total drain	R/W	Ah	Activation of total drain (not pCO ^{ss})		No/Yes	No	
Drv1 offset probe S1 S2 S3	R/W	An	Driver 1 probe calibration	°C / barg	-9.9 to 9.9	0	
Drv2 offset probe S1 S2 S3	R/W	Ao	Driver 2 probe calibration	°C / barg	-9.9 to 9.9	0	
Man.proc.driver1 EEV Position	R/W	Ai	Valve control mode for Driver 1		Auto/Man.	Auto.	
Steps Opening	R/W	Ai	Number of manual valve opening steps Driver 1	Steps	0 to 9999	0	
Position	R	Ai	Display current valve opening steps Driver 1	Steps			
Man.proc.driver2 EEV Position	R/W	Aj	Valve control mode for Driver 2		Auto/Man.	Auto.	
Steps Opening	R/W	Aj	Number of manual valve opening steps Driver 2	Steps	0 to 9999	0	
Position	R	Aj	Display current valve opening steps Driver 2	Steps			
Status driver 1 System's waiting for... Go ahead?	R/W	Ak	Manual release Driver 1 when starting		No/Yes	No	
Status driver 2 System's waiting for... Go ahead?	R/W	Al	Manual release Driver 2 when starting		No/Yes	No	
New maintenance Password:	R/W	Am	Enter new Maintenance password		0 to 9999	1234	
USER		15-button terminal PROG button		6-button PGDO* or Built-in terminal PRG button and USER in the menu			
User password	R/W	P0	Enter User password		0 to 9999	1234	
Limits setpoint temperature: Min: Max:	R/W	P1	Minimum and maximum limits of the temperature set point	°C / °F	-999.9/999.9	-999/999	
Limits setpoint humidity: Min: Max:	R/W	P2	Minimum and maximum limits of the humidity set point	% RH	0.0 to 100.0	00to100.0	
Temperature: Cool differ. Heat differ.	R/W	P3	Proportional heating and cooling temperature bands	°C / °F	0.0/100.0	30...30	
Neutral zone	R/W	P3	Temperature dead zone	°C / °F	0.0/99.9	00	
Dehumid.band Humidity band	R/W	P4	Proportional humidification and dehumidification bands	% RH	0.0 to 99.9	20...20	
Show language mask at start-up	R/W	P5	Display language screen on board power-up		No/Yes	Yes	
Keyboard on/off	R/W	P5	Shutdown unit from button		No/Yes	No	
En.remote On/Off	R/W	P5	Enable ON/OFF from remote		No/Yes	No	
Recovery setpoint	R/W	P6	Recovery set point	°C / °F	0/680	12	
Compensation:	R/W	P7	Enable compensation		No/Yes	No	
Setpoint	R/W	P7	Compensation set point				

Parameter	Type	Ref.	Description	UOM	Range	Default	Notes
Band	R/W	P7	Compensation band				
Offset	R/W	P7	Compensation offset				
Temperature alarm Low offset High offset	R/W	P8	High and low room temperature alarm offset	°C / °F	-999.9T999.9	10.0 to 10.0	
Humidity alarm Low offset High offset	R/W	P9	High and low ambient humidity alarm offset	% RH	0 to 100.0	20.0 to 30.0	
Air temp.supply limit enable:	R/W	Pa	Enable outlet limit function		No/Yes	No	
Setpoint	R/W	Pa	Outlet air set point for the limit function	°C / °F	-999.9T999.9	12.0	
Differenz.	R/W	Pa	Outlet air differential for the limit function	°C / °F	-999.9T999.9	4.0	
Sel.type alarm	R/W	Pb	Assign type of alarm Serious / Minor ½ from AL01 to AL20		S/1/2	5-6-9=S others=1	
Sel.type alarm	R/W	Pc	Assign type of alarm Serious / Minor ½ from AL21 to AL40		S/1/2	26=S others=1	
Sel.type alarm	R/W	Pd	Assign type of alarm Serious / Minor ½ from AL41 to AL60		S/1/2	All = 1	
Sel.type alarm	R/W	Pe	Assign type of alarm Serious / Minor ½ from AL61 to AL69		S/1/2	All = 1	
Identific.number for BMS Network:	R/W	Pf	Board identification number for supervisor network		0...200	1	
Comm.speed:	R/W	Pf	Board communication speed for supervisor network	Baud Rate	1200...19200	1200	
Protocol type:	R/W	Pf	Select serial communication network		CAREL, Modbus, Lon, RS232, GSM	CAREL	
Max.phone n.:	R/W	Pg	Telephone numbers entered for the analogue modem		1..4	1	
Mobile number:	R/W	Pg	Enter telephone numbers for the analogue/digital modem		0 to 9,#,*,@,^	0	
1,2,..	R/W	Pg	Number of rings for the digital modem		0 to 9	0	
Modem password:	R/W	Pg	Access password for the pCO via analogue/digital modem from PC or cellular phone (SMS)		0 to 9999	0	
Modem rings:	R/W	Ph	Number of rings for the analogue modem		0 to 9	0	
Modem type:	R/W	Ph	Type of analogue modem		Tone/Pulse	Tone	
New user password	R/W	Pi	Enter new User password		0 to 9999	1234	
MANUFACTURER		15-button terminal PROG button + MENU		6-button PGDO* or Built-in terminal PRG button and MANUFACTURER in the menu			
Password	R/W	Z0	Enter Manufacturer password		0 to 9999	1234	
CONFIGURATION →							
BMS Network :	R/W	C0	Enable BMS		No/Yes	No	
Printer :	R/W	C0	Enable printer		No/Yes	No	
Select.of temp.:	R/W	C0	Select unit of measure for the temperature probes and the parameters		°C/°F	°C	
Clock board :	R/W	C0	Enable clock board (pCO ¹ and pCO ^{AS} only)		No/Yes	No	
Type of Unit:	R/W	C1	Select type of unit controlled		ED/CW	ED	
Refrigerant:	R/W	C1	Select refrigerant		R22, R134a, R404a, R407C, R410A, R507c, R290, R600, R600a, R717, R744, R728, R1270	R134a	
Compressors :	R/W	C2	Number of compressors (ED unit)		1/2	1	
Unloaders :	R/W	C2	Number of compressor load steps (not pCO ^{AS}) (ED unit)				
Heating mode:	R/W	C2	Heating mode (ED unit)		Heaters/Coil	Heaters	
Heaters n. :	R/W	C2	Number of heaters (ED unit)		0/2/Binary	1	
Valve :	R/W	C2	Type of valve for heating coil (ED unit)		0-10V/3-pt.	0 to 10 Volt	
Battery 1:	R/W	C3	Type of coil (CW unit)		C/H/Cool	C/H	
Valve 1 :	R/W	C3	Type of coil valve (CW unit)		0-10V/3-pt.	0 to 10 Volt	
Heating :	R/W	C3	Heating mode (CW unit)		Heater/ Coil 2	Heater	
Heaters n:	R/W	C3	Number of heaters (CW unit)		0 to 3	2	
Valve 2 :	R/W	C3	Type of valve for heating coil (CW unit)		0-10V/3pt.	0-10 Volt	
Configuration of digital input 5:	R/W	C4	Configuration of digital input 5 (not pCO ^{AS})		Flood, Dirty filters, Smoke/fire	Dirty filters	
Configuration of digital input 12:	R/W	C5	Configuration of digital input 12 (not pCO ^{AS})		Smoke/fire, Flood	-	
Configuration of digital input 1:	R/W	C6	Configuration of digital input 1 (not pCO ^{AS})		Smoke/fire,	-	

Parameter	Type	Ref.	Description	UOM	Range	Default	Notes
					Flood		
Configuration of digital output 7:	R/W	C7	Configuration of digital output 7 (not pCO ^{AS})		Recovery valve, Minor alarm	-	
Configuration of analog input 1:	R/W	C8	Configuration of analogue input 1 (pCOXS only)		Ambient humidity, Outside temperature, Recovery temperature	Ambient humidity	
Configuration of analog input 2:	R/W	C9	Configuration of analogue input 2 (pCOXS only)		Outside temperature, Recovery temperature	Outside temperature	
Configuration of analog input 2:	R/W	C9	Configuration of analogue input 2 (not pCO ^{AS})		Pressure circ.1, Temperature circ.1, Outlet temperature	-	
Configuration of analog input 3:	R/W	Ca	Configuration of analogue input 3 (not pCO ^{AS})		Pressure circ.2, Temperature circ.2, Recovery temperature	-	
Analog outp.1:	R/W	Cb	Configuration of analogue input 1 (not pCO ^{AS})		Recovery valve, analogue fan		
Analog outp.1:	R/W	Cb	Configuration of analogue input 1 (pCOXS only)		Humidifier, recovery damper	Humidifier	
Analog Humidif.:	R/W	Cb	Enable analogue humidifier		No/Yes	No	
Configuration of analog output 2:	R/W	Cc	Configuration of analogue input 2 (pCO ² -pCO1 only)		Recovery valve, analogue humidifier.	Recovery valve	
Recovery damper enabled	R/W	Cd	Enable recovery valve (CW unit)		No/Yes	No	
Main fan damper presence	R/W	Cd	Enable presence of analogue fan (CW unit)		No/Yes	No	
Condensation:	R/W	Ce	Enable condenser control (ED unit)		No/Yes	No	
Cond.type :	R/W	Ce	Select type of condenser		Single, separate	Single	
Output type:	R/W	Ce	Select type of condenser output		Inverter, steps	inverter	
Fans number:	R/W	Ce	Set number of condenser fans for control by steps		1 to 2	1	
PWM output conf. Triac Max	R/W	Cf	Maximum voltage threshold for Triac	%	0 to 100	92	
Triac Min.	R/W	Cf	Minimum voltage threshold for Triac	%	0 to 100	70	
Pulse width	R/W	Cf	Triac impulse duration	m seconds	0 to 10	2	
Dehum.logic:	R/W	Cg	Select type of dehumidification operating logic		N.O./N.C.	N.O.	
Comps.for dehumid:	R/W	Cg	Enable compressors for dehumidification (ED unit)		No/Yes	No	
Cooling valve with dehumid:	R/W	Cg	Enable cooling valve with dehumidification (CW unit)		No/Yes	No	
Integr.humidif. :	R/W	Cg	Enable built-in humidifier (not pCO ^{AS})		No/Yes	No	
Humidifier type	R/W	Ch	Select type of built-in humidifier				
Max.produz.	R/W	Ch	Maximum production	%	0 to 1000		
Board	R/W	Ch	Select type of built-in humidifier control board		PCOUMID200/PCOUMID000	PCOUMID000	
Humidity probe:	R/W	Ci	Enable ambient humidity probe		No/Yes	No	
Type	R/W	Ci	Select type of humidity probe		0 to 1V, Current	Current	
Threshold min.	R/W	Ci	Minimum humidity value	%	0 to 1000	0	
Threshold max.	R/W	Ci	Maximum humidity value	%	0 to 1000	1000	
Pressure1 probe:	R/W	Cj	Enable pressure probe circuit 1		No/Yes	No	
Type	R/W	Cj	Select type of pressure probe circuit 1		Current, 0 to 5V (pCO ¹ -pCO ² , pCO ³ only)	Current	
Threshold min.	R/W	Cj	Minimum pressure value circuit 1	Bar	-200 to 500	0 Bar	
Threshold max.	R/W	Cj	Maximum pressure value circuit 1	Bar	-200 to 500	30 Bar	
Pressure2 probe:	R/W	Ck	Enable pressure probe circuit 2		No/Yes	No	
Type	R/W	Ck	Select type of pressure probe circuit 2		Current, 0 to 5 V (pCO ¹ -pCO ² , pCO ³ only)	Current	

Parameter	Type	Ref.	Description	UOM	Range	Default	Notes
Threshold min.	R/W	Ck	Minimum pressure value circuit 2	Bar	-200 to 500	0 Bar	
Threshold max.	R/W	Ck	Maximum pressure value circuit 2	Bar	-200 to 500	30 Bar	
Room temperature type	R/W	Cl	Type of signal from the room temperature probe		NTC, PT1000 (pCO ² pCO ³ only)	NTC	
Supply air probe	R/W	Cl	Enable outlet probe		No/Yes	No	
Type	R/W	Cl	Type of signal from the outlet temperature probe		NTC, PT1000 (pCO ² pCO ³ only)	NTC	
Ext. temp. probe:	R/W	Cm	Enable outside temperature probe		No/Yes	No	
Type	R/W	Cm	Type of signal from the outside temperature probe		NTC, PT1000 (pCO ² pCO ³ only)	NTC	
Recovery probe:	R/W	Cm	Enable recovery probe		No/Yes	No	
Type	R/W	Cm	Type of signal from the recovery probe		NTC, PT1000 (pCO ² pCO ³ only)	NTC	
Cond.1 temp.:	R/W	Cn	Enable condenser 1 temperature probe		No/Yes	Yes	
Type	R/W	Cn	Type of signal from the condenser 1 temperature probe		NTC, PT1000 (pCO ² pCO ³ only)	NTC	
Cond.2 temp.:	R/W	Cn	Enable condenser 2 temperature probe		No/Yes	Yes	
Type	R/W	Cn	Type of signal from the condenser 2 temperature probe		NTC, PT1000 (pCO ² pCO ³ only)	NTC	
Units configurat. U1: U2: U3:	R/W	Co	pLAN connection class of boards 1 – 3		Present-rotation, Present-no rot., Not present	Present-no rot.	
U4: U5: U6:	R/W	Cp	pLAN connection class of boards 4 – 6		Present-rotation, Present-no rot., Not present	Present-no rot.	
U7: U8:	R/W	Cq	pLAN connection class of boards 7 – 8		Present-rotation, Present-no rot., Not present	Present-no rot.	
PARAMETERS →							
recovery valve	R/W	G0	Enable recovery valve		No/Yes	No	
Rotation Comp. :	R/W	G1	Enable FIFO rotation between compressors		No/Yes	No	
Regulation type:	R/W	G1	Type of temperature control		Prop./P+I	Proportional	
Unload. Logic :	R/W	G1	Logic of the part load contact	%	N.C./N.O.		
Cooling valve (Single valve)	R/W	G2	Star point to open modulating cooling valve (or single valve) with recovery (see G0)	%	0.0 to 100.0	50.0	
Begin End	R/W	G2	Start and end point to open modulating cooling valve (or single valve)	%	0.0 to 100.0	0.0 / 100.0	
Cooling valve 3P (Single valve 3P")	R/W	G3	Start point to open 3-point cooling valve (or single valve) with recovery (see G0)	%	0.0 to 100.0	50.0	
Begin End	R/W	G3	Start and end point to open 3-point cooling valve (or single valve)	%	0.0 to 100.0	0.0 / 100.0	
Heating damper Begin End	R/W	G4	Start and end point to open modulating heating valve	%	0.0 to 100.0	0.0 / 100.0	
Valve 3P hot: Begin End	R/W	G5	Start and end point to open 3-point heating valve	%	0.0 to 100.0	0.0 / 100.0	
Damper/Valve recovery Begin End	R/W	G6	Start and end point to open modulating recovery valve	%	0.0 to 100.0	0.0 / 100.0	
Main fan damper Min. speed Max. speed	R/W	G7	Minimum and maximum modulating fan speed	V	0.0 to 100.0	0.0 / 100.0	
Dehumid speed	R/W	G7	Outlet fan speed during dehumidification	V	0.0 to 100.0	5.0	
Analog humidifier Min. speed Max. speed	R/W	G8	Minimum and maximum analogue humidifier speed	V	0.0 to 100.0	0.0 / 100.0	
Low temp. limit (stop dehumidif.): Differential	R/W	G9	Low temperature limit differential (stop dehumidification)	°C / °F	0T999	50	
Offset	R/W	G9	Temperature offset to restart dehumidification	°C / °F	0T999	40	
Addict. features Drain by low setp.	R/W	Ga	Disable drain water to reduce set point		No/Yes	No	
Inactivity drain	R/W	Ga	Disable drain due to extended humidifier standby		No/Yes	No	
Periodic flushing	R/W	Ga	Disable non-serious alarm messages on humidifier.		No/Yes	No	
Addit. features Unpowered drain	R/W	Gb	Enable drain without power		N/Y	N	
Cylinder warning	R/W	Gb	Enable cylinder depleted messages		N/Y	N	

Parameter	Type	Ref.	Description	UOM	Range	Default	Notes
Addit.features Cyl.maint.warn:	R/W	Gc	Cylinder lifetime limit	h	0 to 4000	1500	
Flush period:	R/W	Gc	Interval between two periodicals drain cycles	h	1 to 120	24	
Inactiv.drain:	R/W	Gc	Days to wait for drain due to inactivity	G	1 to 199	3	
Addit.features Time to off:	R/W	Gd	Delay time in shutdown	sec	0 to 120	0	
Force Cond:	R/W	Gd	Water conductivity (0=automatic measurement)	uS/cm	0 to 2000	0	
Thresh.conduct. Warning:	R/W	Ge	High conductivity warning limit	uS/cm	0/B6	2000	
Alarm:	R/W	Ge	High conductivity alarm limit	uS/cm	B5/2000	1500	
Humidifier Percentage timing Drain (resp.H3)	R/W	Gf	Set percentage of time for drain to dilute	%	50 to 200	100	
Evap. (resp.H4)	R/W	Gf	Set frequency of drain cycles to dilute	%	50 to 200	100	
Pressure probe High thresh.	R/W	Gg	High pressure alarm set point	bar	-99.9 to 99.9	23.5	
Differ.HP	R/W	Gg	High pressure alarm differential	bar	-99.9 to 99.9	1.0	
Condensation Setpoint	R/W	Gh	Condensing pressure set point	bar	-99.9 to 99.9	14.0	
Different.	R/W	Gh	Condensing pressure differential	bar	-99.9 to 99.9	2.0	
Speedup time	R/W	Gh	Modulating condenser fan speed-up time	seconds	0 to 999	2	
Condensation Setpoint	R/W	Gi	Condensing temperature set point	°C / °F	-99.9T99.9	55.0	
Different.	R/W	Gi	Condensing temperature differential	°C / °F	-99.9T99.9	1.0	
Speedup time	R/W	Gi	Modulating condenser fan speed-up time	seconds	0 to 999	2	
Condens.fans Low speed High speed	R/W	Gj	Minimum and maximum modulating condenser fan speed	Volt	0 to 10.0	0.0 / 10.0	
Hp cond.prevent enabled:	R/W	Gk	Enable high pressure alarm Prevent function		No/Yes	No	
Setpoint	R/W	Gk	Prevent function pressure set point	Bar	-99.9 to 99.9	20.0	
Different.	R/W	Gk	Prevent function pressure differential	Bar	-99.9 to 99.9	2.0	
Hp cond.prevent enabled:	R/W	Gl	Enable high pressure alarm Prevent function		No/Yes	No	
Setpoint	R/W	Gl	Prevent function temperature set point	°C / °F	-99.9T99.9	70.0	
Different.	R/W	Gl	Prevent function temperature differential	°C / °F	-99.9T99.9	1.0	
Master control enable	R/W	Gm	Enable Carel network Master Control function		No/Yes	No	
Rotation type	R/W	Gn	Unit rotation mode in the pLAN		Automatic, Time bands, Operating hours.	Auto	
Stand-by units	R/W	Gn	Number of units set in Standby mode		0/No. units in present - rotation mode	0	
Rotation time	R/W	Gn	Automatic rotation interval for units in pLAN	Hours	1 to 240	24	
Timezones units Rotation time	R/W	Go	Hour of automatic rotation for units in pLAN	Hours	0 to 23	22	
Timezones units Rotation time	R/W	Go	Minutes of automatic rotation for units in pLAN	Minutes	0 to 59	00	
Every .. days	R/W	Go	Interval in days for automatic rotation in pLAN network	Days	1 to 7	3	
Force unit by temperature	R/W	Gp	Enable force units on function in pLAN		No/Yes	No	
Delay low temp. Delay high temp.	R/W	Gp	Force on delay for high and low room temperature	Minutes	0 to 999	3/3	
Force unit by low temperature Differential	R/W	Gq	Differential to force unit on in network for low room temperature	°C / °F	0T99.9	8	
Offset	R/W	Gq	Offset to force unit on in network for low room temperature	°C / °F	0T99.9	4	
Force unit by high temperature Differential	R/W	Gr	Differential to force unit on in network for high room temperature	°C / °F	0T99.9	8	
Offset	R/W	Gr	Offset to force unit on in network for high room temperature	°C / °F	0T99.9	4	
CAREL EXV DRIVERS / System parameters →							
Number drivers connected	R/W	F0	Number of drivers				
Battery Driver1	R/W	F0	Type of EVD driver		400-pLAN / 400tLAN	400-pLAN	
Battery Driver2	R/W	F0	Enable driver battery		N / Y	N	
Type drive EVD	R/W	F1	Type of driver probes		See EVD400 manual	---	
Type of valve	R/W	F2	Type of valve		See EVD400	CAREL	

Parameter	Type	Ref.	Description	UOM	Range	Default	Notes
					manual	E2V	
Custom vlv config. minimum steps	R/W	F3	Custom Valve: minimum steps		0 to 8100	0	
Custom vlv config. Maximum steps	R/W	F3	Custom Valve: maximum steps		0 to 8100	1600	
Custom vlv config. Closing step	R/W	F3	Custom Valve: closing steps		0 to 8100	3600	
Custom valve configuration Opening EXTRAs	R/W	F4	Custom Valve: enable extra step in opening		N / Y	N	
Custom valve configuration Closing EXTRAs	R/W	F4	Custom Valve: enable extra step in closing		N / Y	N	
Custom valve configuration Phase current	R/W	F5	Custom Valve: operating current	mA	0 to 1000	250	
Custom valve configuration Still current	R/W	F6	Custom Valve: holding current	mA	0 to 1000	100	
Custom valve configuration Step rate	R/W	F6	Custom Valve: frequency	Hertz	32 to 330	100	
Custom valve configuration Duty-cycle	R/W	F6	Custom Valve: duty cycle	%	0 to 100	50	
EEV stand-by steps EEV position with 0% power demand	R/W	F7	Rest steps		0 to 8100	0	
S1 probe limits pressure limits Min value	R/W	F8	Minimum value for pressure probe S1	Bar	-9.9 to 10.0	-1.0	
S1 probe limits pressure limits Max value	R/W	F8	Maximum value for pressure probe S1	Bar	3.5 to 200.0	9.3	
Alarms delay Low SuperHeat	R/W	F9	Low superheat alarm delay	seconds	0 to 3600	120	
Alarms delay High SuperHeat	R/W	F9	High superheat alarm delay	minutes	0 to 500	20	
Alarms delay LOP	R/W	Fa	LOP alarm delay	seconds	0 to 3600	120	
Alarms delay MOP	R/W	Fa	MOP alarm delay	seconds	0 to 3600	0	
Alarms delay Delay probe error	R/W	Fb	Probe alarm delay	%	0 to 100	60	
CAREL EXV DRIVERS / Autoseup →							
Circuit/EEV Ratio for startup opening	R/W	Q0	Percentage ratio between cooling capacity and Driver capacity	%	0 to 100	60	
Compressor type	R/W	Q1	Type of compressor or unit		See manual EVD400	---	
Capacity control	R/W	Q1	Type of capacity control		See manual EVD400	---	
Capacity control Cool	R/W	Q2	Type of exchanger in cooling mode		See manual EVD400	---	
Minimum saturated temperature Cool Mode	R/W	Q3	LOP protection threshold	°C	-70.0 to 50.0	-2.0	
Maximun saturated temperature Cool Mode	R/W	Q4	MOP protection threshold	°C	-50.0 to 90.0	12.0	
High SuperHeat alarm threshold	R/W	Q5	High superheat alarm threshold	°C	0.0 to 99.9	20.0	
CAREL EXV DRIVERS / Advanced →							
Circ./EEV Ratio	R/W	N0	Percentage ratio between cooling capacity and Driver capacity	%	0 to 100	0	
Prop. Gain	R/W	N1	Proportional gain		0.0 to 99.9	0	
Integral time	R/W	N1	Integral time	sec	0 to 999	0	
SuperHeat set C1	R/W	N2	Superheat set point circuit 1	°C	2.0 to 50.0	0	
Low SuperHeat	R/W	N2	Threshold for low superheat protection circuit 1	°C	0 to 9.9	0	
SuperHeat set C1	R/W	N3	Superheat set point circuit 2	°C	2.0 to 50.0	0	
Low SuperHeat	R/W	N3	Threshold for low superheat protection circuit 2	°C	0 to 9.9	0	
SHeat dead zone	R/W	N4	Superheat dead band	°C	0 to 9.9	0	
Derivative time	R/W	N4	Derivative time	sec	0 to 99.9	0	
Low SHeat int.time	R/W	N5	Integral time for low superheat protection	sec	0 to 30.0	0	
LOP integral time	R/W	N5	Integral time for LOP protection threshold	sec	0 to 25.5	0	
MOP integral time	R/W	N6	Integral time for MOP protection threshold	sec	0 to 25.5	0	
MOP startup delay	R/W	N6	MOP protection delay at start-up	sec	0 to 500	0	
Dynamic prop. Gain?	R/W	N7	Enable dynamic proportional factor		Y/N	N	
Blocked valve check	R/W	N7	Waiting time for forced closing/opening with valve blocked	sec	0 to 999	0	
Hi TCond.prot.	R/W	N8	High condensing temp. protection threshold	°C	0 to 99.9	0	

Parameter	Type	Ref.	Description	UOM	Range	Default	Notes
Hi TCond.int.time	R/W	N8	Integral time for high condensing temp. threshold	sec	0 to 25.5	0	
TIMES →							
Delay time start fan Delay time stop fan	R/W	T0	Outlet fan start and stop delay	seconds	0 to 999	10 / 20	
Integration time P+I only	R/W	T1	Integral time for P+I temperature control	seconds	0 to 9999	600	
Opening time 3p valve	R/W	T1	3-point freecooling travel time	seconds	0 to 9999	180	
Delay alarm low pressure	R/W	T2	Low pressure alarm delay	seconds	0 to 9999	180	
Delay alarm Low/High Temp./Humi.	R/W	T2	High-low temperature-humidity alarm delay	seconds	0 to 9999	600	
Delay alarm Relay 8	R/W	T3	Relay 8 activation delay	seconds	0 to 999	0	
Delay alarm Relay 7	R/W	T3	Relay 7 activation delay	seconds	0 to 999	0	
Delay alarm air flow	R/W	T4	Air flow switch alarm delay	seconds	0 to 9999	10	
Delay alarm water flow	R/W	T4	Water flow alarm delay	seconds	0 to 9999	10	
Min.off time compressors	R/W	T5	Minimum compressor off time	seconds	0 to 9999	180	
Min. time Power-On compressor	R/W	T5	Minimum compressor on time	seconds	0 to 9999	60	
Start delay same compressor	R/W	T6	Delay between compressor starts	seconds	0 to 9999	360	
Start delay diff. compressors	R/W	T6	Minimum delay between starts different of compressors	seconds	0 to 9999	10	
Delay time among unloaders	R/W	T7	Start delay between load steps	seconds	0 to 9999	10	
Delay time among resistors	R/W	T8	Activation delay between heaters	seconds	0 to 9999	3	
INITIALISATION →							
Insert password to install default values	R/W	V0	Enter password for restore default values function		0 to 9999	1234	
Erase history alarm	R/W	V1	Delete BASIC alarm LOG		No/Yes	No	
New manufacturer password	R/W	V2	Enter new Manufacturer password		0 to 9999	1234	
CHANGE UNIT		15-button terminal INFO button (switches to the next board in the pLAN)		6-button PGD0* or Built-in terminal PRG button and MANUFACTURER in the menu			
Switch to unit address:	R/W	L0	Select the unit to be controlled by the terminal		1 to 8	-	
Current Unit:	R	L0	Display the pLAN address of the board controlled		1 to 8	-	

8. Screens

The screens are sub-divided into 5 categories:

- screens, not password-protected: these are located in all the branches, except for “prog” and “menu+prog”, and show the values read by the probes, the status of the alarms, the operating hours of the devices, the time and date; they are also used to set the temperature and humidity set point and the clock. These screens are indicated by the “@” symbol in the following table of parameters.
- **USER** screens, password-protected (1234, modifiable): these are accessed by pressing the “prog” button, and are used to set the main functions (times, set points, differentials) for the devices connected; the screens that relate to functions that are not available are not displayed. These screens are indicated by the “⓪” symbol in the following table of parameters.
- **MAINTENANCE** screens, password-protected (1234, modifiable): these are accessed by pressing the “maintenance” button, and are used for performing the periodical checks on the devices, calibrating the probes, modifying the operating hours and manually activating the devices. These screens are indicated by the “Ⓜ” symbol in the following table of parameters.
- **CLOCK** screens, password-protected (1234, modifiable): these are accessed by pressing the “clock” button and are used to set and activate the temperature and humidity time bands. These screens are indicated by the “ⓐ” symbol in the following table of parameters.
- **MANUFACTURER** screens, password-protected (1234, modifiable): these are accessed by pressing the “menu+prog” buttons and are used to configure the air-conditioning unit, enable the main functions and select the devices connected. These screens are indicated by the “Ⓢ” symbol in the following table of parameters.

8.1 List of the screens

The following list shows the screens available on the display. The columns in the table represent the loop of screens, with the first screen (A0, B0...) being the one that is displayed when pressing the corresponding button, after which the arrow buttons can be used to scroll the other screens. The codes (Ax, Bx, Cx...) are displayed in the top right corner of the screens, making them easy to identify. The meaning of the symbols Ⓢ, ⓪... is explained in the previous paragraph. The annotation PSW indicates screens that are protected by password.

ESC	PRG MAN	PRINTER	INPUT/OUTPUT	CLOCK	SET POINT	PRG USER	MANUFACTURER	
⓪ M0	⓪ A0	⓪ H0	⓪ I0	⓪ K0	⓪ S0	PSW ⓪ P0	PSW Z0	
⓪ M1	⓪ A1	⓪ H1	⓪ I1	PSW K1	⓪ S1	⓪ P1	CONFIGURATION →	⓪ C0
⓪ M2	⓪ A2		⓪ I2	ⓐ K2		⓪ P2		⓪ C1
	⓪ A3		⓪ I3	ⓐ K3		⓪ P3		⓪ C2
	⓪ A4		⓪ I4	ⓐ K4		⓪ P4		⓪ C3
	PSW A5		⓪ I5	ⓐ K5		⓪ P5		⓪ C4
	Ⓜ A6		⓪ I6	ⓐ K6		⓪ P6		⓪ C5
	Ⓜ A7		⓪ I7	ⓐ K7		⓪ P7		⓪ C6
	Ⓜ A8		⓪ I8	ⓐ K8		⓪ P8		⓪ C7
	Ⓜ A9		⓪ I9	ⓐ K9		⓪ P9		⓪ C8
	Ⓜ Aa		⓪ Ia	ⓐ Ka		⓪ Pa		⓪ C9
	Ⓜ Ab		⓪ Ib			⓪ Pb		⓪ Ca
	Ⓜ Ac		⓪ Ic			⓪ Pc		⓪ Cb
	Ⓜ Ad		⓪ Id			⓪ Pd		⓪ Cc
	Ⓜ Ae		⓪ Ie			⓪ Pe		⓪ Cd
	Ⓜ Af		⓪ If			⓪ Pf		⓪ Ce
	Ⓜ Ag		⓪ Ig			⓪ Pg		⓪ Cf
	Ⓜ Ah		⓪ Ih			⓪ Ph		⓪ Cg
	Ⓜ Ai		⓪ Ii			⓪ Pi		⓪ Cj
	Ⓜ Aj		⓪ Ij					⓪ Ci
	Ⓜ Ak		⓪ Ik					⓪ Cl
	Ⓜ Al		⓪ Il					⓪ Cm
	Ⓜ Am		⓪ Im					⓪ Cn
			⓪ In					⓪ Co
			⓪ Io					⓪ Cp
			⓪ Ip					⓪ Co
			⓪ Iq					⓪ Cp
			⓪ Ir					⓪ Cq
			⓪ Is				PARAMETERS →	⓪ G0
			⓪ It					⓪ G1
			⓪ Iu					⓪ G2
			⓪ Iv					⓪ G3
			⓪ Iw					⓪ G4
								⓪ G5
								⓪ G6
								⓪ G7
								⓪ G8
								⓪ G9
								⓪ Ga
								⓪ Gb

ESC	PRG MAN	PRINTER	INPUT/OUTPUT	CLOCK	SET POINT	PRG USER	MANUFACTURER	
								④ Gc
								④ Gd
								④ Ge
								④ Gf
								④ Gg
								④ Gh
								④ Gi
								④ Gj
								④ Gk
								④ Gl
								④ Gm
								④ Gn
								④ Go
								④ Gr
							CAREL EXV DRIVER→	④ F0
							System parameters	④ F1
								④ F2
								④ F3
								④ F4
								④ F5
								④ F6
								④ F7
								④ F8
								④ F9
								④ Fa
								④ Fb
							CAREL EXV DRIVER→	④ N0
							Advanced	④ N1
								④ N2
								④ N3
								④ N4
								④ N5
								④ N6
								④ N7
								④ N8
							CAREL EXV DRIVER→	④ Q0
							Autosetup	④ Q1
								④ Q2
								④ Q3
								④ Q4
								④ Q5
							TIMES →	④ T0
								④ T1
								④ T2
								④ T3
								④ T4
								④ T5
								④ T6
								④ T7
								④ T8
							INITIALISATION →	④ V0
								④ V1
								④ V2

9. EVD400 electronic expansion valve

The EVDriver module for the control of electronic expansion valves (EEV) in pLAN networks allows superheat control on the suction side for more efficient and versatile operation of the unit.

Efficient because the optimisation and stabilisation of the flow of refrigerant to the evaporator increases the overall performance of the installation, at the same time guaranteeing the safety (less activations of the low pressure switch, less return of liquid refrigerant to the compressor, ...). In addition, if the EEV is correctly sized, the use of floating condensing (and evaporation) pressure or a low set point significantly increases the efficiency of the installation, guaranteeing lower energy consumption, with higher cooling efficiency. Versatile because the electronic expansion valve allows the use of compressors with different capacities and operating in different conditions.

The use of an expansion valve requires the installation not only of the EVDriver and the expansion valve, but also of a temperature sensor and a pressure transducer, both fitted at the end of the evaporator on the refrigerant side (on the compressor intake pipe). See the diagram below to better understand the typical layout of the installation. The priorities to be considered for the optimum control of the refrigeration system involve achieving a high and constant refrigerating efficiency, as well as low and stable superheat values. The heart of the control system is a PID control algorithm, with settable superheat coefficients.

The following values can be set:

LOW	(Low superheat with programmable integral time and threshold)
LOP	(Low evaporation pressure, operating only in transients, with programmable integral time and threshold)
MOP	(High evaporation pressure, with programmable integral time and threshold)
HiTcond	(High condensing pressure, activated with condensing pressure probe read by pCO, with programmable integral time and threshold)

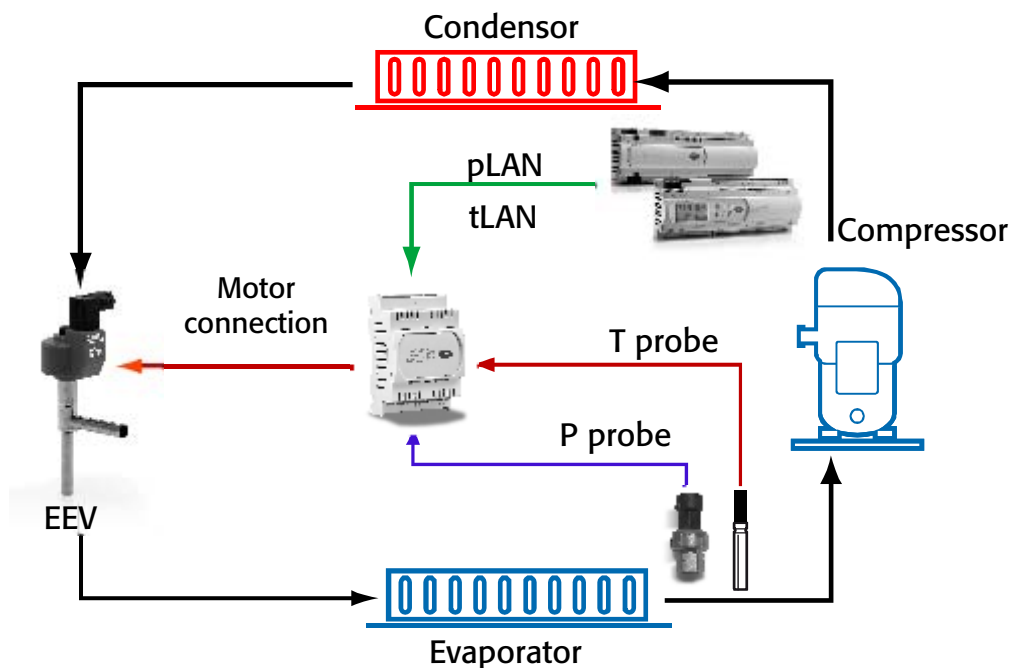

For the parameter and address settings of the EVD400 see the technical manual (Carel code +030220225)

10. Temperature control

The heating and cooling devices are managed based on the temperature value measured by the room (or intake temperature) probe. The temperature measured is compared against the set temperature (set point); the devices are enabled based on the difference between the two values. The proportional band identifies the air-conditioning unit working range and can take different values in heating and cooling mode. The dead zone identifies the a zone around the set point in which the devices are not activated. The following diagrams show the action of the heating and cooling devices. The percentage values indicate the opening of the modulating valves.

The heating and cooling valve start and end opening parameters correspond to 0% and 100% respectively (default values) and are different for the two valves; if necessary, the values can be modified to delay the opening or bring complete opening forward.

10.1 Direct expansion units

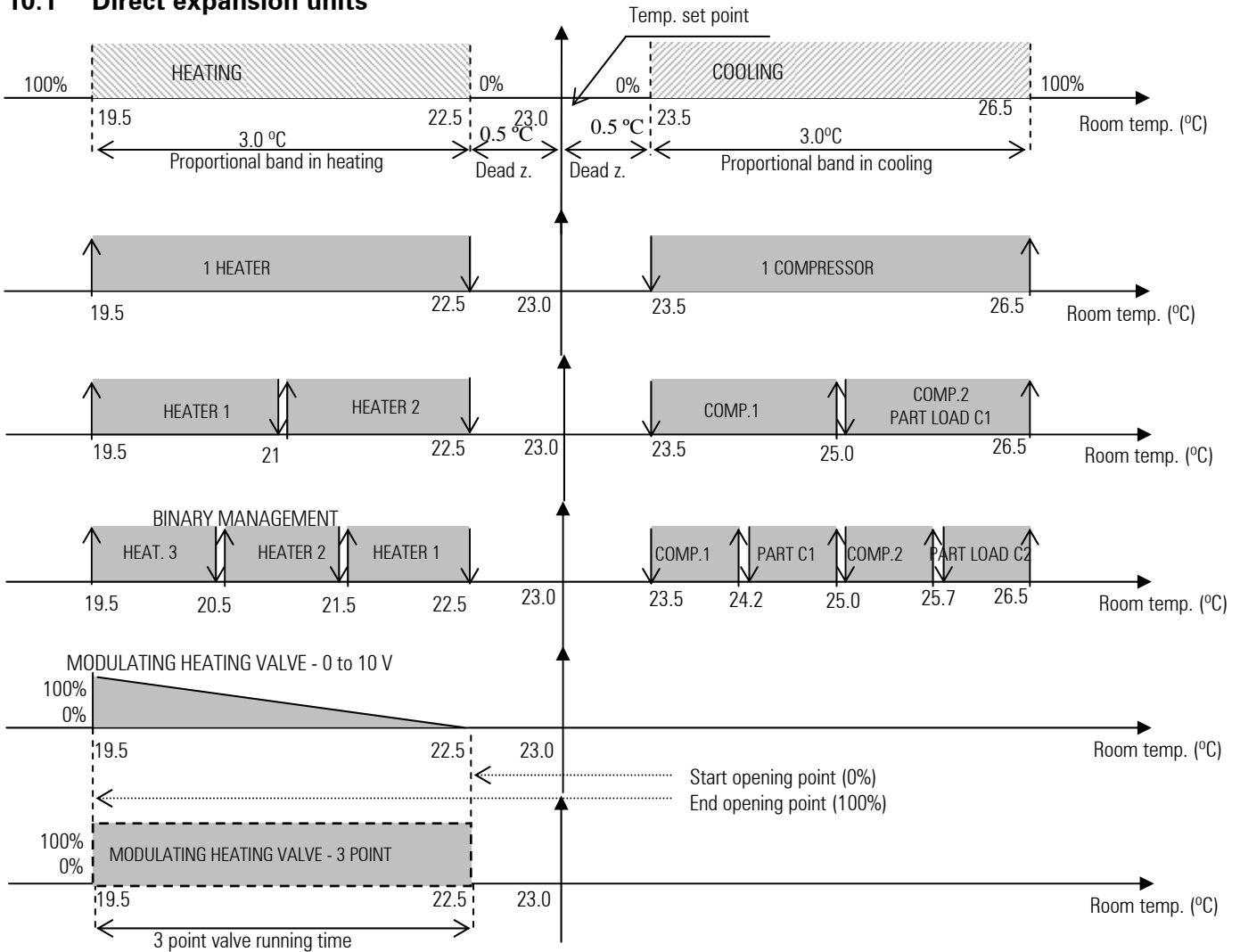

10.2 Other temperature functions

The high and low temperature alarms cause an alarm signal and have modifiable delay times.

The dehumidification stop differential establishes the minimum temperature below which dehumidification is interrupted. Dehumidification can start again if temperature returns above the value established by the humidification start offset; the differential and offset are modifiable.

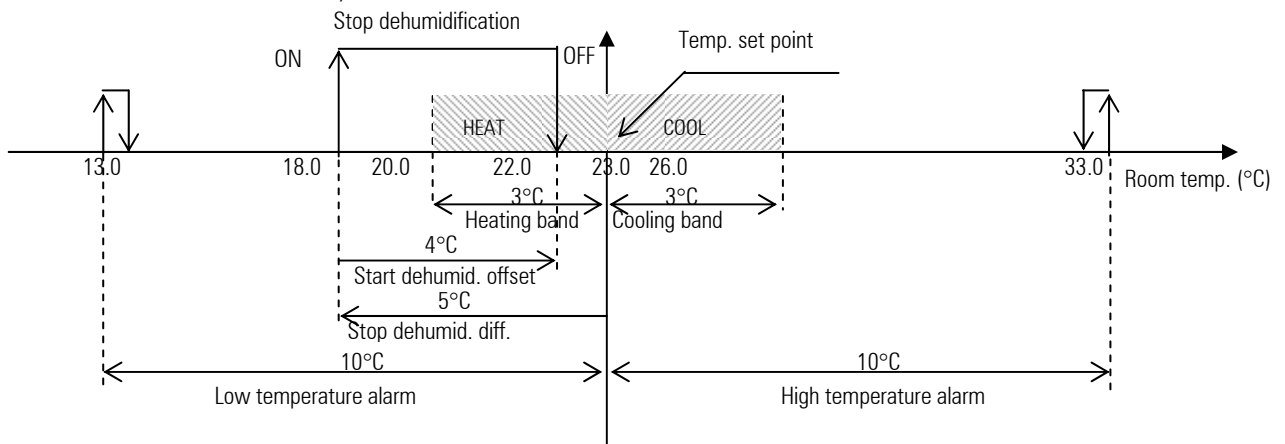

10.3 Units with two water coils

These units feature both a hot and a cold water coil. Heating can also be performed using the electric heaters. The following diagram shows the behaviour of the cooling devices, while for the heating devices refer to the paragraph on the direct expansion units.

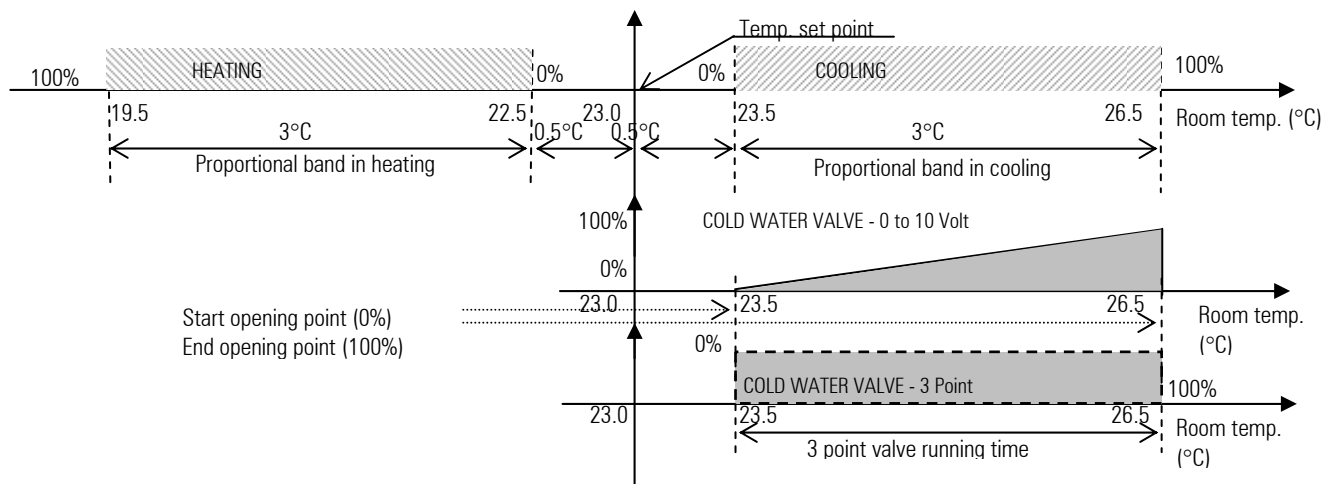

10.4 Units with one water coil

In the units with just one water coil, this coil manages both the heating and cooling functions, depending on the water that flows through the coil. In practical terms, it is the same as if there were two separate coils. The operation of the coil depends on a Cooling / Heating digital contact that "informs" the board if the water is hot or cold; if the "type of water" circulating corresponds to the requirement, the valve is modulated to control the temperature.

Heating can also be performed using the electric heaters or, if necessary, a heating coil. For details on the operation of the coil and the heaters, refer to the previous paragraphs.

11. Humidity control

The humidification and dehumidification devices are managed based on the humidity value measured by the ambient (or intake) probe. The humidity measured is compared against the set humidity (set point); the devices are enabled based on the difference between the two values. The proportional band identifies the working range of the air-conditioning unit and can have different values in humidification and dehumidification modes. There is also a fixed dead zone around the set point. This dead zone is equal to: proportional humidification band/10 for humidification control, and proportional dehumidification band/10 for dehumidification control.

Humidification is available for medium and small (only for 0 to 10 Volt modulating output) boards only. Dehumidification, on the other hand, is always available, either by activating the cooling devices enabled for this function, or using a contact for an external dehumidifier or reducing the outlet fan speed.

In case of medium boards, humidification can be managed as follows:

- built-in humidifier
- 0 to 10 Volt modulating output (available on small board too);
- ON/OFF contact.

Dehumidification can be managed as follows:

- ON/OFF contact for an external dehumidifier or for reducing the outlet fan speed
- activation of the compressors (including part load operation, if present)
- 100% activation of the 0 to 10 volt or three-point modulating cooling valve

The voltage free dehumidification ON/OFF contact is always managed, whereas the cooling devices depend on the unit configuration and the selection made by the user. The 0 to 10 Volt modulating output for the outlet fan in dehumidification mode is automatically reduced by 50% (modifiable); with ON/OFF fan control, use the digital contact for reducing the speed.

The following diagrams show the action of the humidification and dehumidification devices. The percentage values indicate the opening of the modulating valves.

11.1 Direct expansion units

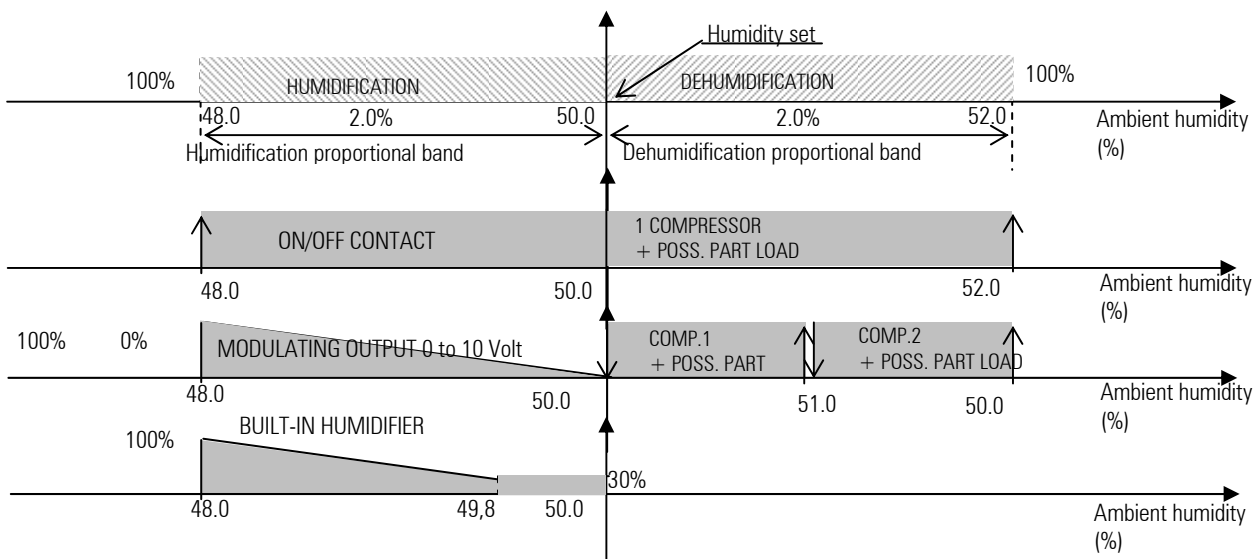

11.2 Units with water coils

In the units with water coils, the dehumidification devices are the cold water coils. The humidification devices, on the other hand, are the direct expansion units (ON/OFF contact, modulating 0 to 10 Volt signal, built-in humidifier) and consequently for the operation of these see the previous paragraph. Below is a description of the behaviour of the dehumidification devices. The percentage values indicate the opening of the modulating valves. Note that the cold water coils do not have modulating but rather total activation for dehumidification, both with 3-point valves and 0 to 10 Volt valves.

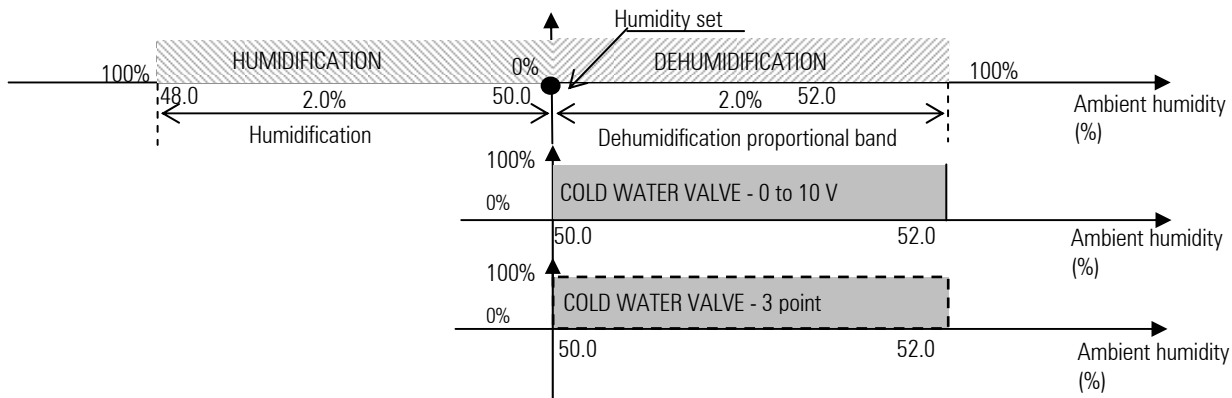

11.3 Other humidity control functions

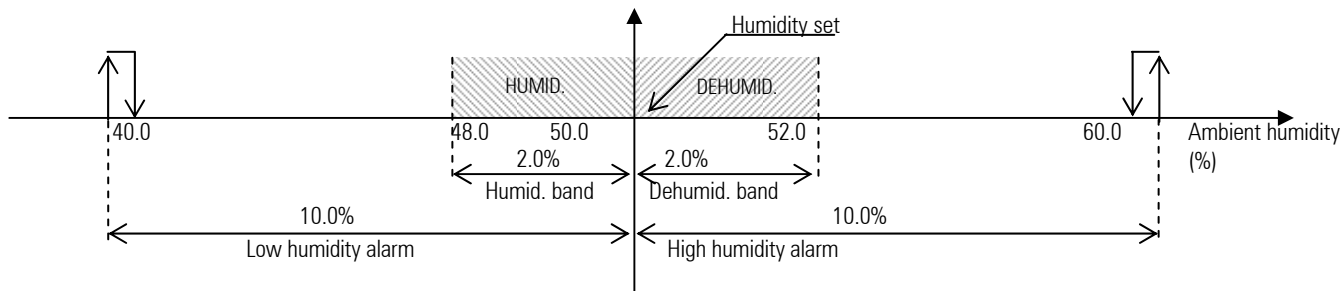

The high and low humidity alarms cause a signal on an alarm screen and have a modifiable delay.

12. Built-in humidifier

Integrated management of a CAREL immersed electrode humidifier. The pCO¹ - pCO² - pCO³ boards manage all the functions, from the reading of the humidifier parameters to the control of the devices (fill, drain, capacity) by relay. The humidifier parameters (current, conductivity, level) are not read directly, but rather using an optional card (PCOUMID000/200). The built-in humidifier is available for the pCO¹ - pCO² - pCO³ medium boards only and replaces the electronic controller normally fitted on the humidifier. The LCD terminal features screens for controlling the humidifier. Humidifiers from 1.5 to 15 kg/h (single cylinder) and 90 kg/h (two cylinders), three-phase or single-phase, with supply voltage from 208 to 575 volts can be managed. The program controls the steam production and the humidifier operating conditions based on the humidifier current and ambient humidity signals; furthermore, it manages and displays all states and alarms.

12.1 Setting the parameters for selecting the humidifier

The following parameters are required to configure the humidifier:

- TYPE OF HUMIDIFIER

PARAMETER VALUE	RATED CAPACITY	RATED VOLTAGE	PHASES	NUMBER OF TAM TURNS
0	1.5 kg/h	200 V	single-phase	1
1	1.5 kg/h	208 V	single-phase	1
2	1.5 kg/h	230 V	single-phase	2
3	1.5 kg/h	200 V	single-phase (red.)	1
4	1.5 kg/h	208 V	single-phase (red.)	2
5	1.5 kg/h	230 V	single-phase (red.)	2
6	3 kg/h	200 V	single-phase	2
7	3 kg/h	208 V	single-phase	2
8	3 kg/h	230 V	single-phase	1
9	3 kg/h	200 V	three-phase	1
10	3 kg/h	208 V	three-phase	1
11	3 kg/h	230 V	three-phase	1
12	3 kg/h	400 V	three-phase	2
13	3 kg/h	460 V	three-phase	2
14	3 kg/h	200 V	single-phase (red.)	2
15	3 kg/h	208 V	single-phase (red.)	2
16	3 kg/h	230 V	single-phase (red.)	1
17	5 Kg/h	200 V	single-phase	2
18	5 Kg/h	208 V	single-phase	2
19	5 Kg/h	230 V	single-phase	2
20	5 kg/h	200 V	three-phase	2
21	5 kg/h	208 V	three-phase	1
22	5 kg/h	230 V	three-phase	1
23	5 kg/h	400 V	three-phase	1
24	5 kg/h	460 V	three-phase	2
25	5 kg/h	575 V	three-phase	2
26	8 kg/h	200 V	three-phase	2
27	8 kg/h	208 V	three-phase	2
28	8 kg/h	230 V	three-phase	2
29	8 kg/h	400 V	three-phase	1
30	8 kg/h	460 V	three-phase	1
31	8 kg/h	575 V	three-phase	1
32	9 kg/h	208 V	single-phase	1
33	9 kg/h	230 V	single-phase	1
34	10 kg/h	200 V	three-phase	1
35	10 kg/h	208 V	three-phase	1
36	10 kg/h	230 V	three-phase	1
37	10 kg/h	400 V	three-phase	1
38	10 kg/h	460V	three-phase	1
39	10 kg/h	575 V	three-phase	1
40	15 kg/h	200 V	three-phase	1
41	15 kg/h	208 V	three-phase	1
42	15 kg/h	230 V	three-phase	1
43	15 kg/h	400 V	three-phase	1
44	15 kg/h	460 V	three-phase	1
45	15 kg/h	575 V	three-phase	1
46	25 kg/h	200 V	three-phase	1
47	25 kg/h	208 V	three-phase	1
48	25 kg/h	230 V	three-phase	1
49	25 kg/h	400 V	three-phase	1
50	25 kg/h	460 V	three-phase	1
51	25 kg/h	575 V	three-phase	1
52	35 kg/h	200 V	three-phase	1
53	35 kg/h	208 V	three-phase	1
54	35 kg/h	230 V	three-phase	1
55	35 kg/h	400 V	three-phase	1
56	35 kg/h	460 V	three-phase	1
57	35 kg/h	575 V	three-phase	1
58	45 kg/h	208 V	three-phase	1

PARAMETER VALUE	RATED CAPACITY	RATED VOLTAGE	PHASES	NUMBER OF TAM TURNS
59	45 kg/h	230 V	three-phase	1
60	45 kg/h	400 V	three-phase	1
61	45 kg/h	460 V	three-phase	1
62	45 kg/h	575 V	three-phase	1
63	65 kg/h	400 V	three-phase	1
64	65 kg/h	460 V	three-phase	1
65	65 kg/h	575 V	three-phase	1
66	90 kg/h	208 V	three-phase	1
67	90 kg/h	230 V	three-phase	1
68	90 kg/h	400 V	three-phase	1
69	90 kg/h	460 V	three-phase	1
70	90 kg/h	575 V	three-phase	1
71	130 kg/h	400 V	three-phase	1
72	130 kg/h	460 V	three-phase	1
73	130 kg/h	575 V	three-phase	1

Other models of humidifier will be added in the future when available.

PRODUCTION SET POINT: maximum hourly production of steam, between 20% and 100% of rated production

TYPE OF OPTIONAL BOARD: 2 equivalent models can be chosen: PCOUMID000 and PCOUMID200

To select the end scale value of the current transformer (TAM), refer to the rated current of the humidifier, displayed on screen **Ih** in the I/O branch (0= 5 A, 1=10 A, 2=15 A, 3= 30 A, 4=50 A, 5=70 A).

12.2 Humidity and steam production control

The steam production of the humidifier is controlled according to:

- the humidity
- the production set on the screen (value between 30% and 100% of rated production)

Humidity control is performed by the program based on the reading of the humidity probe, the humidity set point and the humidity differential. The program calculates the proportional humidity error, ERP:

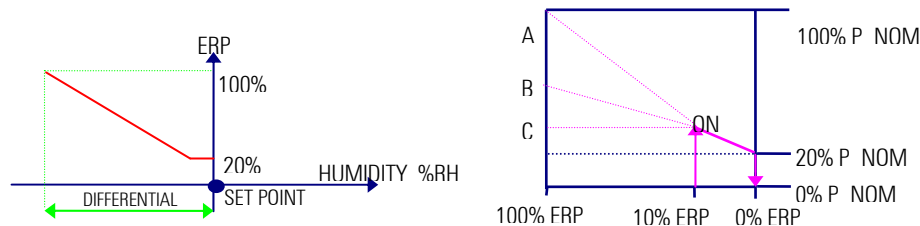

The graph of humidifier production control is based on the rated production, set production and proportional error (ERP):

ERP = proportional humidity error

Set production:

- A = 100% rated production
- B = 75% rated production
- C = 45% rated production

The humidifier has a minimum capacity equal to 20% of the rated production (for technical reasons) when ERP is between 0% and 20%, and increases as the ERP increases until reaching the set production when ERP=100%.

Below is a brief description of the algorithm embedded in the bios for the management of a humidifier with 1 or 2 immersed electrode cylinders

In this type of humidifier, the steam is produced by boiling the water contained inside the cylinder. This occurs by simply filling the cylinder with water and applying a voltage to the electrodes. According to the Joule effect, the current will tend to heat the water until it boils.

The current that runs through the electrodes in the cylinder depends essentially on the voltage applied to the electrodes, the conductivity of the water inside the cylinder and the level of the water.

The aim of the algorithm is to maintain the current that runs through the electrodes at a reference value so as to ensure the percentage of steam production required, according to the readings of the humidity probes and the parameters set by the user.

During evaporation, the level of the water falls, and as the current is directly proportional to the quantity of water present in the cylinder, to keep it constant the cylinder would need to be constantly filled with minute quantities of water.

To avoid this, the current is maintained within a certain range around the reference value, by repeated "water fill/evaporation" cycles.

As well as the level of water in the cylinder, the other factor that determines the current level is the **conductivity of the water inside** the cylinder. In fact, during the fill/evaporation cycles, the conductivity of the water will tend to increase, due to the increase in the concentration of salts in the water. The conductivity of the water inside the cylinder is measured indirectly, by calculating the time required for a complete evaporation cycle. This time is then compared against a reference (typical for each cylinder) and, if lower, a drain cycle is performed (called drain to dilute) and then the cylinder is topped up with less conductive mains water.

The humidifier also features a **conductivity meter** that measures the conductivity of the mains water entering the appliance during the filling cycles. In the case of high conductivity of the supply water, the control algorithm first signals a **pre-alarm** (that doesn't stop operation) and then, if necessary, an **alarm** (that stops operation). This is essential to avoid the introduction of excessively conductive water into the cylinder, which may compromise the correct operation of the humidifier.

Another fundamental element, installed at the top of the cylinder, is the high level sensor, used to detect any water or foam.

The high level electrodes may be activated for one of the following reasons:

- over-filling of water in the boiler – when the unit is OFF – due to a leak in the fill solenoid valve;
- high water level when first filling the cylinder;
- high water level following the depletion of the cylinder due to fouling on the plates;
- formation of foam.

In the first case, when the high level sensor is activated, the algorithm stops operation and signals a **cylinder full alarm**, while in the other three cases the humidifier responds by draining the water so as to decrease the level.

In the event of repeated activations of the high level sensor, the algorithm evaluates the possibility that the causes may be due to the presence of foam. In this case, if after having performed a complete washing cycle (complete emptying-complete refill-complete emptying) the high level sensor continues to be activated, the controller signals a **foam alarm** (that does not stop operation).

A crucial point in the operation of the humidifier is the control of any excess current levels. In fact, whenever voltage is applied to the electrodes in the cylinder, after a period of inactivity, there may be short but very intense peaks in current. If the current is excessive in this initial period, the algorithm responds by immediately switching OFF the electrodes and performing a drain cycle. If the excess current continues, the operation of the humidifier is stopped and a **high current alarm** is signalled. The algorithm also controls the drain cycles, signalling a **drain alarm** if there is no appreciable decrease in current when the drain cycle starts. Vice-versa, a **no water alarm** will be signalled if there is no appreciable increase in current when the humidifier is being filled with water.

13. Recovery coil

Recovery is an optional function: an additional cooling coil that uses water from an external source (e.g. evaporative tower) is activated if the water temperature that flows through the coil is quite low. This is used to save the running costs of the installation. The coil is activated using an ON/OFF contract or with 0 to 10 Volt modulating control.

The following diagram shows the conditions for the activation of the recovery coil: there must be a cooling requirement and the recovery water temperature must be less than the Recovery set point - Recovery differential.

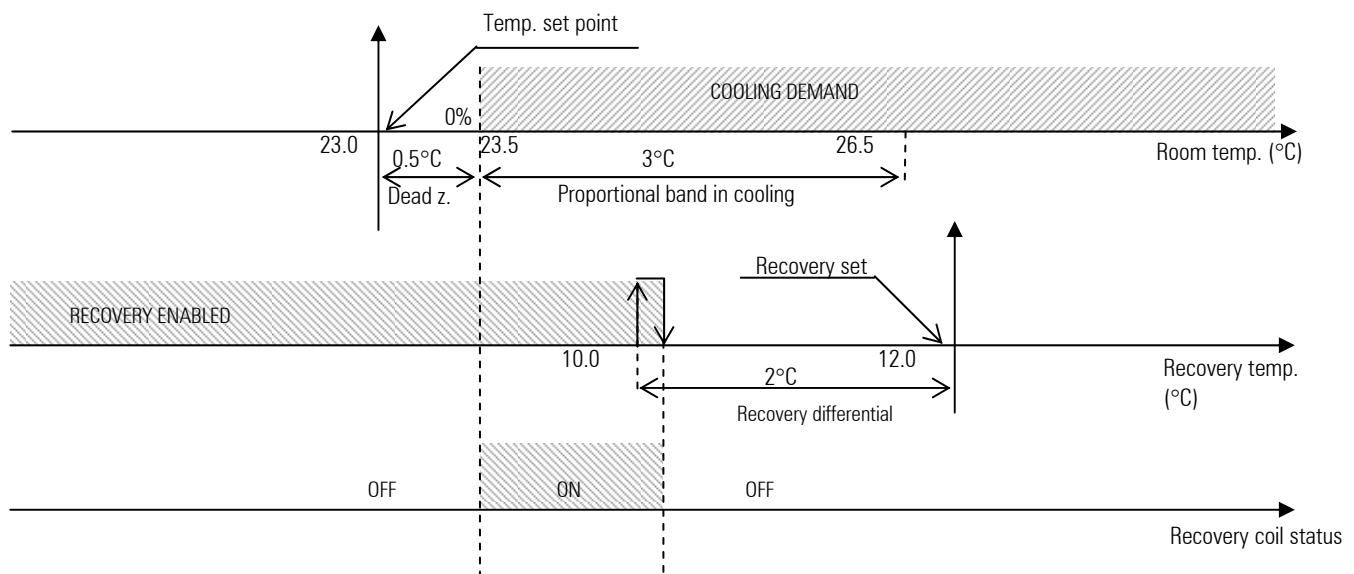

13.1 Recovery without the cooling devices

In reference to the conditions illustrated in the previous diagram, only the recovery coil is activated, while the standard cooling devices are not on; as can be seen in the following diagram, the entire cooling proportional band is covered by the recovery coil.

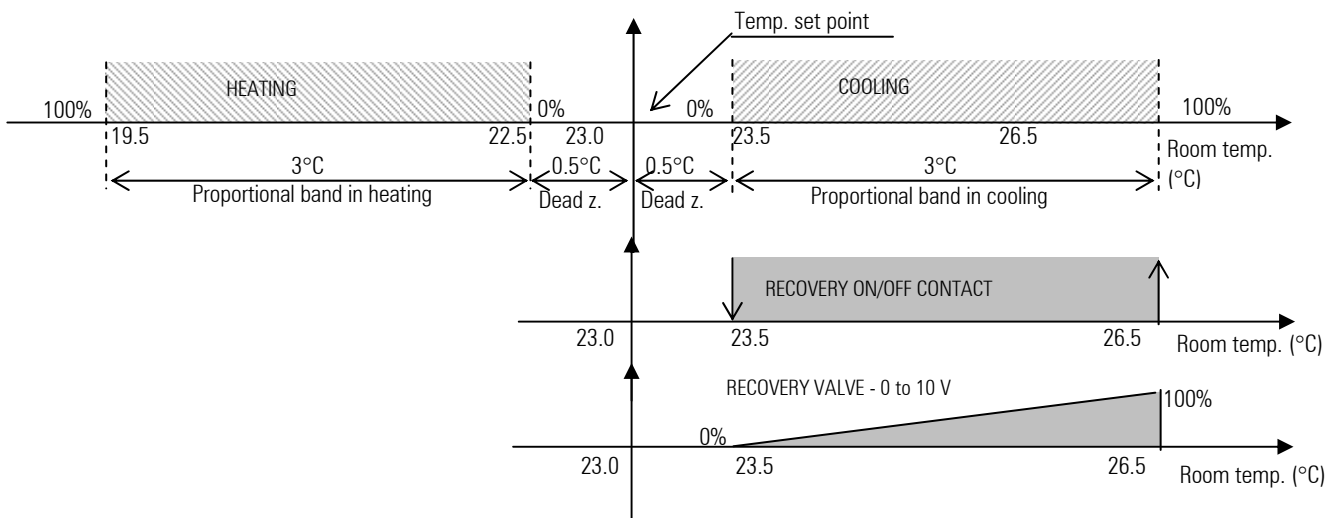

13.2 Recovery with the cooling devices on, direct expansion units

When the recovery coil is active the standard cooling devices are only ON if the room temperature exceeds a certain value; adding the effect of the recovery coil plus the cooling devices lowers the temperature, yet before reaching the set point the cooling devices are switched off again. The cooling devices in this case help the recovery function, but do not replace it. In the following diagram, it can be seen how the steps of the cooling devices are shifted to ensure energy savings.

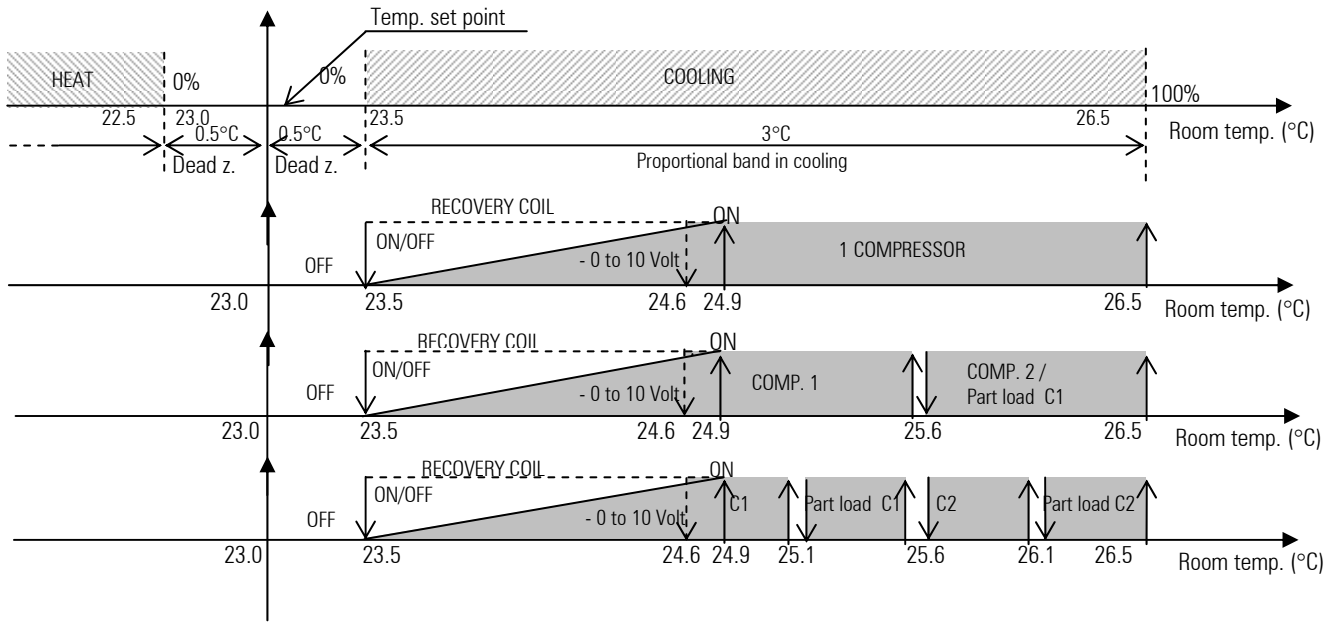

13.3 Recovery with the cooling devices on, units with water coils

The following diagram shows how the activation of the cooling coil is shifted to ensure energy savings.

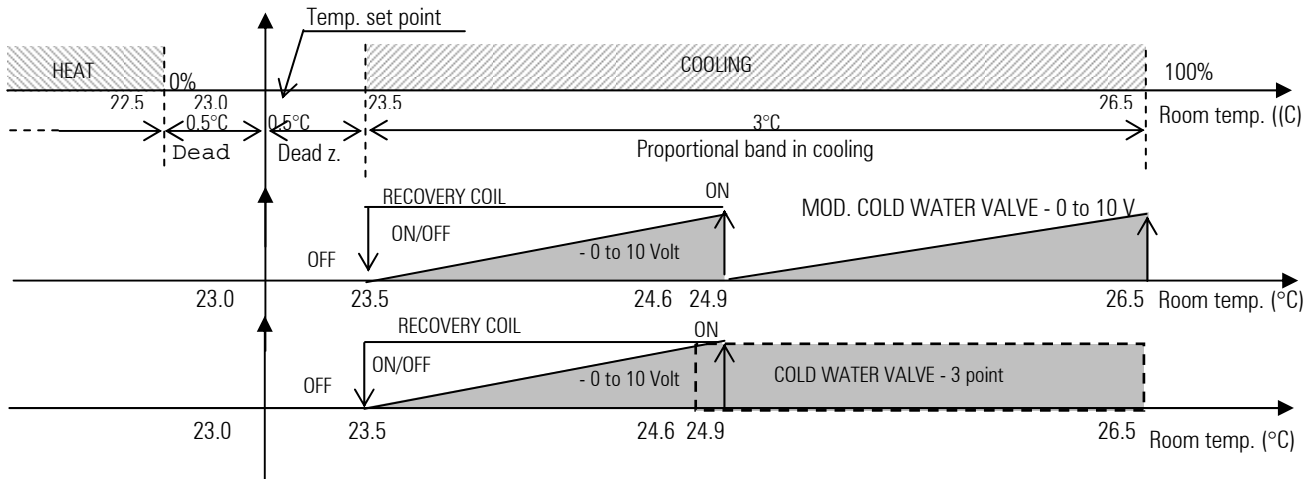

14. Outlet limit

This function protects the environment and the people inside against excessively cold air, so as to ensure comfort and safeguard health. A temperature probe must be fitted at the outlet of the air-conditioner, and the following parameters need to be set: Outlet set point and Outlet differential; these identify a limitation zone, as seen in the following diagram.

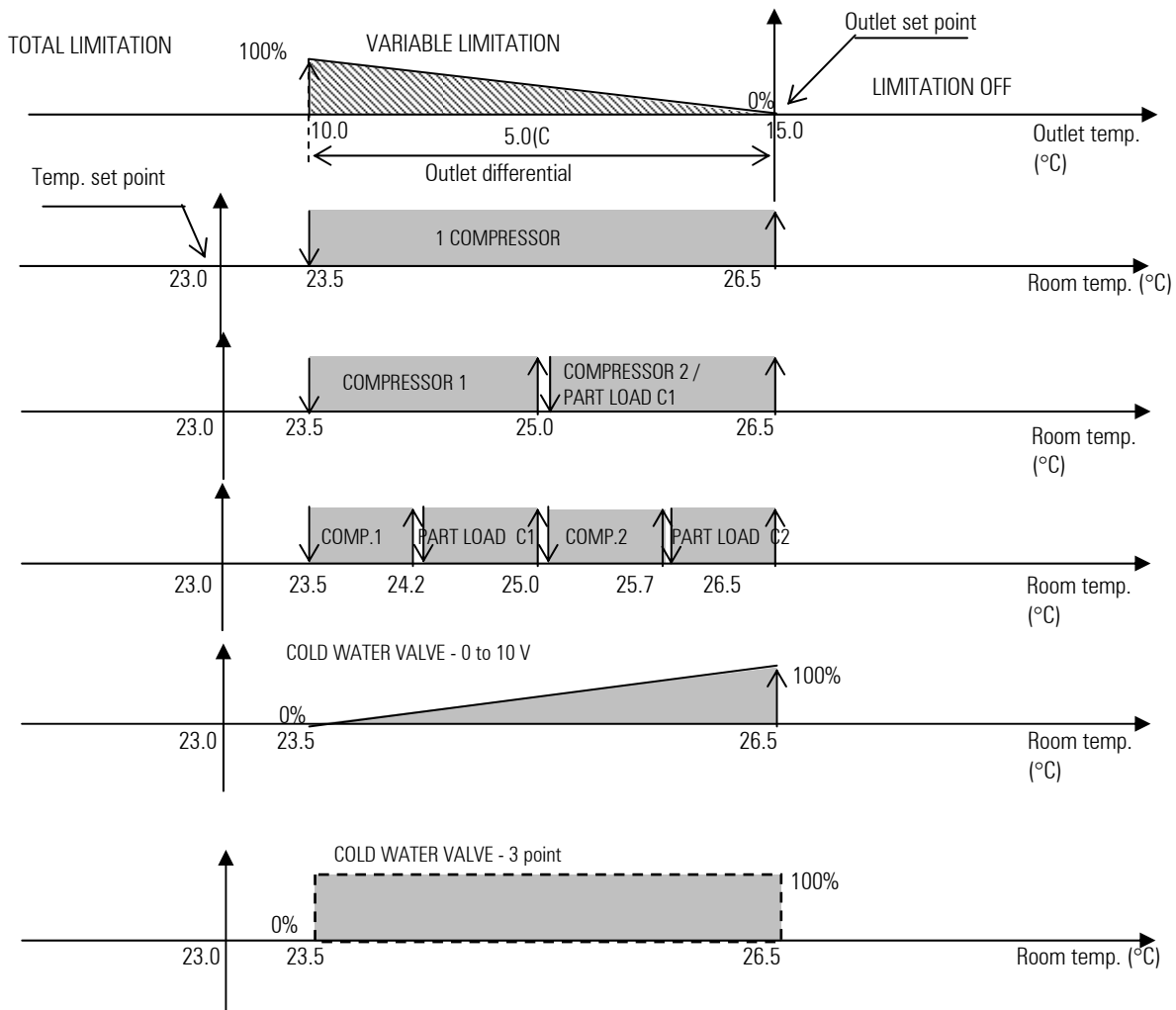

As can be seen, if the outlet temperature is between the outlet set point and the outlet differential, the cooling devices are only partially limited, to a greater extent the lower the temperature.

The activation of the limit function in dehumidification mode is different, where the modulation zone is skipped, because when dehumidifying the cooling devices are always used at maximum output. In practice, the devices are switched off only if the outlet temperature is lower than the differential, and are started again if the outlet temperature reaches the outlet set point, as illustrated in the following diagram:

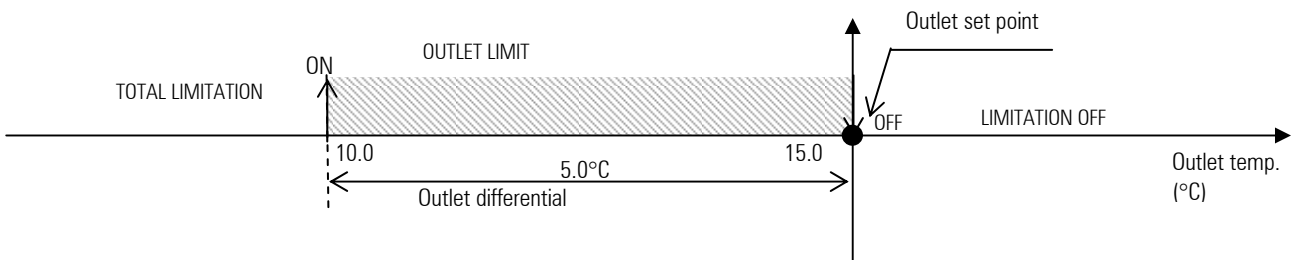

15. Condenser fans

Condensing pressure control is available on direct expansion units where the fans are managed based on the pressure in the condenser coil and the status of the compressors, and are activated using 0 to 10 V modulating outputs or digital outputs (on medium boards). The control function is based on the condensing pressure set point and differential, as illustrated below:

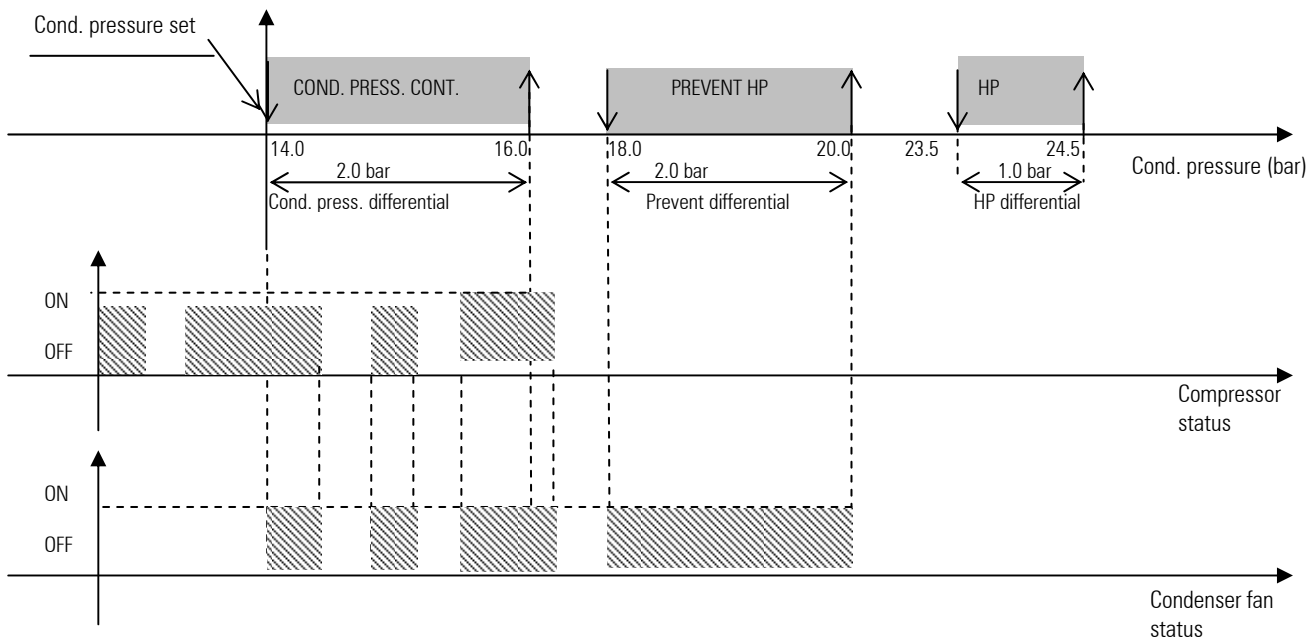

For operation with modulating outputs, refer to the following diagram:

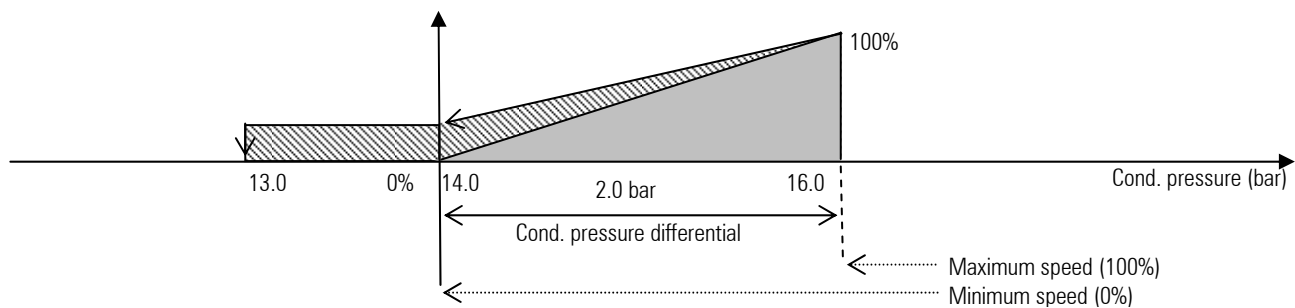

The voltage values corresponding to the minimum and maximum speeds of the fan can be set, between 0 and 10 V; if the minimum value set is greater than 0 V, when stopping the fan is operated at the minimum speed for 1.0 bar below the condensing pressure set point, before switching off, as per the diagram above.

15.1 Single or separate coil

With single coils only one output is activated, ON/OFF or modulating as desired. In the event of units with at least one condenser probe and ON/OFF outputs enabled (medium boards), two ON/OFF outputs can be activated in sequence, dividing the differential in two.

With separate coils two distinct outputs are activated, one per circuit, ON/OFF or modulating, as desired.

15.2 Number of probes

It should be stressed first of all that the activation of the fans not only considers the values read by the probes, but also the status of the compressors.

With just one probe and with separate coils, the activation of the fans on both circuits is based on the value read by the same probe.

With two probes and a single coil, the activation of the fans is based on the higher value between the two probes.

With two probes and separate coils, the activation of the fans in each circuit is based on the value read by its own probe.

With no probe, the fans are started at the same time as the compressors; with a single coil, when at least one compressor is on, the fans will start; with separate coils, each compressor controls the fans in its own circuit.

15.3 Prevent function

Prevention of the high pressure alarm when the compressors are OFF. Normally the condenser fans only start when the compressors are on, but in this case they are forced on so as to lower the pressure and attempt to prevent the high pressure alarm that would shutdown the unit. The increase in pressure with the compressors OFF may occur due to radiation on the coil. With 0 to 10 V modulating fans there is no modulation in this phase.

15.4 Speed-up function

To overcome the inertia when starting high power modulating fans, at start-up they can be operated at maximum speed for a few seconds, then the speed decreases to the set value and modulation starts.

15.5 Pressure – temperature conversion

Both pressure probes and temperature probes can be used. When using pressure probes, the screens in the I/O branch show the temperature value corresponding to the pressure for each probe, keeping account of the type of refrigerant used, as selected by a parameter in the manufacturer branch.

16. Temperature set point compensation

The temperature set point can be automatically “compensated” for reasons of comfort. Imagine, for example, a shopping centre where people enter and exit frequently. If the inside temperature is 10°C lower than the outside temperature, the difference may bother the people inside or affect their health; in fact, the maximum difference between the inside temperature and the outside temperature for optimum comfort should not exceed 6°C. The compensation function in this case increases the set point by 4°C, consequently increasing the temperature of the centre, and in this way the difference between the inside temperature and the outside temperature does not exceed 6°C.

To use the compensation function, a temperature probe is installed outside. The function is managed based on the values of the compensation set point, differential and offset parameters, as shown in the following diagram:

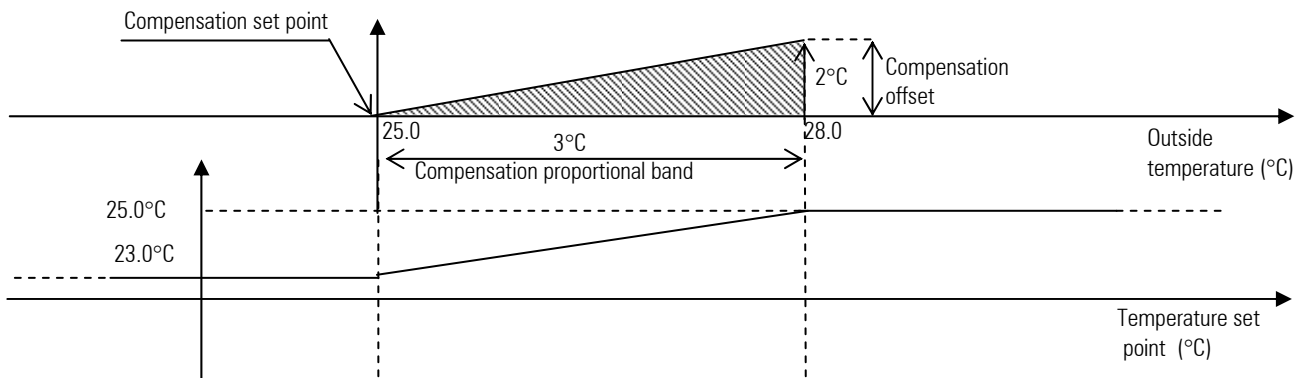

17. Compressors

The compressors are managed as simple ON/OFF loads. A maximum of 2 can be managed, and each can feature capacity control. In total, then, the compressors + load steps give 4 cooling steps.

17.1 Capacity control

This operates with N.O. (normally open relay) or N.C. (normally closed relay) logic. The steps are activated with a settable delay after the compressors. The steps are only available on medium boards. In dehumidification mode, the steps are activated together with the compressors, to achieve the maximum cooling capacity.

17.2 Rotation

The rotation of the compressors follows F.I.F.O. logic (first in, first out). The compressor that starts first is the first to stop, and the last to stop is the last to start. The aim of this function is to balance the operating hours of the compressors.

17.3 Times

17.3.1 Minimum on time

This sets the minimum time (in seconds) that compressors operate when activated. Even if called to stop, the compressor can only be deactivated after this time.

17.3.2 Minimum off time

This sets the minimum time (in seconds) that the compressors remain OFF. If called to start, the compressor can only be activated after this time.

17.3.3 Minimum time between starts of different compressors

This represents the minimum time (in seconds) that must elapse between the start of one device and the next. This time is used to avoid simultaneous starts that would cause excessive peak energy consumption.

17.3.4 Minimum time between starts of the same compressor

This establishes the minimum time (in seconds) that must elapse between two starts of the same device. This parameter is used to limit the number of starts per hour. If, for example, the maximum number of starts / hour allowed by the manufacturer is 10, simply set a time of 360 seconds to ensure this limit is observed.

17.3.5 Minimum capacity control start time

This establishes the minimum time that must elapse between the start of the compressor and the activation of part load operation. The parameter is present only if the load steps have been selected.

17.4 Compressor alarms

The compressor alarms are divided between two digital inputs, except for the ED configuration with 2 compressors on small boards, where the alarms are managed by a single digital input.

When there are two digital inputs, these take the meaning of thermal overload / high pressure and low pressure.

When there is just one digital input, this takes the meaning of general alarm. If one of the alarm inputs is not used, it must be electrically closed on the 24 Vac power supply.

For the electrical connections of the alarm digital inputs, refer to the technical manual on the pCO boards.

17.4.1 High pressure - thermal overload

Immediate alarm caused by an external pressure switch or a thermal cutout; the digital input switches from closed to open and the compressor is immediately stopped. Reset is manual, that is, the user must press the Alarm button on the terminal to be able to restart the compressor, as long as the pressure switch or the thermal cutout have been reset and the digital input is closed. After the compressor has stopped, the safety times are enabled; for this reason, after the alarm has been reset, the compressor cannot start again immediately.

17.4.2 Low pressure

Delayed alarm caused by an external pressure switch, the opening of the digital input starts two timers; if at the end of the time (set on the screen) the contact is open, the compressor stops and the alarm is activated. If the contact closes again before the timer has elapsed, the alarm is not activated and the timer is reset. The timers are: delay with compressor in stable operation and delay at compressor start. The delay in stable operation is always counted, while the delay at compressor start is counted only if the input opens immediately on compressor power-up, and is used to allow time for the fluid to stabilise. The two timers are counted one after the other.

Reset is manual, that is, the user must press the Alarm button on the terminal to be able to restart the compressor, as long as the pressure switch has been reset and the digital input is closed. After the compressor has stopped, the safety times are enabled; for this reason, after the alarm has been reset, the compressor cannot start again immediately.

17.4.3 General alarm

This alarm groups all the safety devices on the compressor in one digital input, a solution used on small boards with two compressors. The alarm is signalled immediately when the digital input opens and stops the compressor. Reset is manual, that is, the user must press the Alarm button on the terminal to be able to restart the compressor, as long as the digital input is closed. After the compressor has stopped, the safety times are enabled; for this reason, after the alarm has been reset, the compressor cannot start again immediately.

18. Heaters

The heaters are managed as simple ON/OFF loads. Normally up to 2 heaters with the same output can be managed, connected directly to the 2 outputs.

“Binary management” is used to manage three heating steps using two outputs. This has two possible uses:

- management of 2 loads with different outputs;
- management of 3 loads.

To use this system, an electronic recogniser is required (NOT supplied) that, connected to the outputs, both reads the logic and activates the loads. The outputs behave in the following mode:

			CODE	2 DIFFERENT LOADS	3 LOADS
STEP 1	Relay 1=On	Relay 2=OFF	10	Heater 1=ON / Heater 2=OFF	Heat 1=ON / Heat 2=OFF / Heat 3=OFF
STEP 2	Relay 1=OFF	Relay 2=On	01	Heater 1=OFF / Heater 2=ON	Heat 1=ON / Heat 2=ON / Heat 3=OFF
STEP 3	Relay 1=On	Relay 2=On	11	Heater 1=ON / Heater 2=ON	Heat 1=ON / Heat 2=ON / Heat 3=ON

The outputs are activated with a slight delay to avoid simultaneous peaks.

18.1 Heater alarms

Each heater features a digital input to be connected to a thermal cutout or circuit breaker to signal any anomalies.

If one of the inputs is not used, it must be electrically closed on the 24 Vac power supply.

The alarm is immediate, and is activated when the digital input switches from closed to open; the heater is immediately stopped. Reset is manual, that is, the user must press the Alarm button on the terminal to be able to restart the heaters, as long as the thermal cutout - circuit breaker has been reset, closing the digital input.

19. Modulating valves

19.1 Three point valves

These are valves with 3 electrical contacts (in addition to the power supply): common, open and close. These contacts must be connected to the two relays on the pCO boards, the opening relay and the closing relay. Based on the activation time of the relay, the opening of the valves ranges from 0% to 100%, with a travel time called the "running time" (time used to totally open or close, this is a characteristic of the valve). The relays are never activated at the same time, so the valves either open, close or are OFF.

The degree of opening of the valves is calculated based on the proportion between the temperature differential and the running time; when the room temperature is equal to the set point the valves are closed, then the more the temperature moves away from the set point, the more the valves will open, up to the maximum when the temperature is greater than or equal to the set point + / - the differential. During operation, many partial openings and closings are performed, and the program knows the degree of opening of the valves at all times, by adding and subtracting all the partial times complete since the board was powered on.

19.1.1 Realignment

As can be imagined, the 3-point valves are not easily managed by the program, as there is no feedback to precisely know their exact position. Indeed, a small discrepancy between the time calculated by the program and the actual activation of the relay, or mechanical friction of the valves that stops their movement, would mean that the actual degree of opening no longer corresponds to the value calculated by the program. To overcome this problem, the following solutions are available:

- whenever the temperature control requires the total opening or closing of a valve, the program increases the activation time of the opening or closing relays by 25%, to ensure complete closing / opening.
- whenever the board is powered (ON), the valves are closed totally for the running time, and only after this they start modulating based on the control requirements.

19.2 0 to 10 Volt valves

These are valves that use a 0 to 10 Volt modulating signal from the pCO to change their opening from 0% to 100%.

The 0 to 10 Volt electrical signal is directly proportional to the temperature proportional band. These valves have no alignment problems as in the case of the 3-point valves, given that their degree of opening is directly proportional to the value of the analogue output.

20. Outlet fan

The outlet fan always remains on when the unit is ON. It can be managed by an ON/OFF output or a modulating output. There are two alarms relating to the fan, thermal overload and air flow switch, which automatically switch the unit OFF. Description of modulating management:

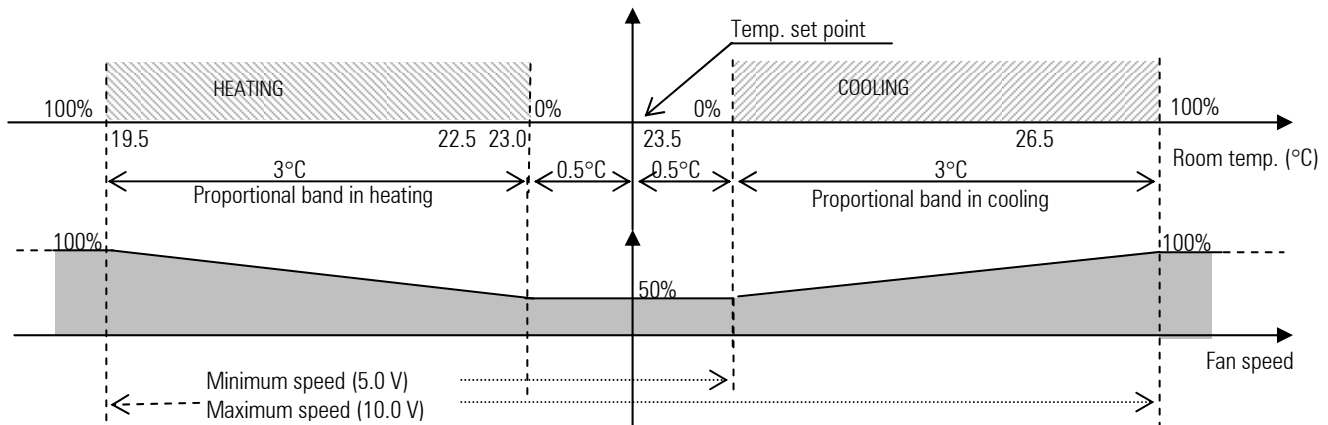

It should be noted how in dehumidification mode the speed is automatically reduced to the default value of 5.0 V (50%), modifiable. The minimum and maximum speed can be set, as default these are 5.0 V and 10.0 V.

21. Manual device management

The devices connected to the outputs can be enabled manually without using the timers, compressor rotation and independent of the control and probe values. In manual mode, the only available support is the management of the alarms safeguarding the devices. The activation of the analogue outputs in manual mode forces a value between 0 V and 10 V.

The manual procedure can only be activated if the unit has been switched OFF from the button and ends automatically 30 minutes after the manual activation of the last device, or alternatively by disabling manual mode on all the devices.

During the manual management of the devices, the air-conditioner cannot be switched ON. This operating mode is identified by the message "Manual procedure" on the last row of the display, on the main Menu screen. The activation parameters are located in the Maintenance branch screens, and are password protected.

22. Switching the unit on and off

L'accensione dell'unità può essere fatta in due modi a seconda del terminale che si sta utilizzando:

The switch on unit is different among the different display:

- PGD0 6 keys or Built in: key PRG jump into main menu, scroll menu until "On-Off Unit", enter on the on-off mask
- PGD 15 keys: key On/Off

22.1 Automatic unit start-up and standby

The boards connected in the pLAN network have the advantage of being able to be managed directly by the program in certain "critical situations", that is, if anomalies occur (alarms, blackout...), or alternatively due to the "Rotation" and "Forcing" functions.

The program bases its action on a number of parameters that can be displayed and modifies only on the board with pLAN add. 1:

- connection class of the boards: Not present, Present / No Rotation, Present / Rotation. There are 8 parameters, one for each board. Not present: the unit is not connected. Present / No Rotation: the unit is physically connected to the pLAN network but is excluded from the rotation function (it can still manage the shared terminal, the prints and the CAREL Master Control function). Present / Rotation: the unit also takes part in the rotation function
- number of units in Standby mode: this establishes how many units, from those selected in Present / Rotation mode, must, on power-up from the button go to Standby mode (that is, OFF, awaiting activation). The parameter is automatically limited between 0 and the total number of units set as Present / Rotation minus one, to guarantee that at least one unit starts.

IMPORTANT. The functions described below cannot be performed if:

- there are not at least two units selected in Present / Rotation mode
- the number of units in Standby set is equal to 0

The functions are managed by the board with pLAN address 1; if this is disconnected from the pLAN network or shuts down due to a blackout, the boards in Standby are activated and the functions in question will be suspended until unit 1 is reset. Vice-versa, switching unit 1 ON/OFF from the button or the Remote ON/OFF does not stop the network functions.

22.1.1 Critical situations

The units in Present / Rotation mode and in Standby are activated in one of the following critical situations involving the boards that are on:

- power failure on one of the boards (blackout);
- serious alarm on one of the boards (each alarm can be set as Serious or Minor), which activates alarm relay number 8;
- one of the boards is disconnected from the pLAN network due to the disconnection of the RS485 line;
- one of the boards is switched off from the button or the remote ON/OFF digital input;
- one of the boards is switched off due to an alarm (see the table of alarms).

For each unit subject to one of the situations listed above, a board in Standby is automatically activated to restore the number of units on. If, for example, two units break down or are disconnected, the program starts two Standby units; when one of the units in the critical situation is reset, this is started again and the spare unit returns to Standby mode. If a critical situation occurs on the Standby unit, nothing happens at a pLAN level, except for the alarm signal on the unit in question.

22.1.2 Forcing

A unit in Present / Rotation mode and in Standby is activated automatically in the event where a unit that is on cannot manage to reach the temperature set point in a certain time, due to the excessive thermal load. Each unit on in this situation can request the activation of a Standby unit. The parameters to be set for the forcing function are the Differential, Offset and Delay, which are different for heating and cooling. The following diagram illustrates the function:

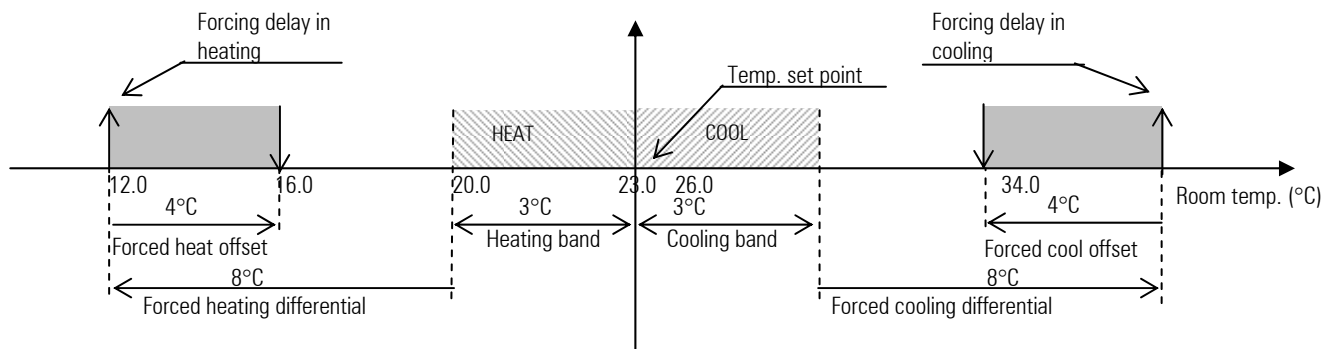

22.1.3 Fixed time rotation

In an installation made up of units on and units in Standby, differences occur in the operating hours that cause the first to "age" before the others. To overcome this situation, the pLAN network can rotate the operation of the units, so as to balance the operating hours. In practice, the rotation function places a unit that is on in Standby and starts a unit in Standby.

Fixed time rotation is based on a parameter that establishes the time interval between rotations. The minimum time that can be set is 0h and in this case automatic rotation is activated every 5 minutes as a test. The maximum time is 240h (10 days). The time starts counting when the unit with pLAN address 1 is started, as this manages the rotation function. Rotation may occur following the logic of the pLAN addresses or the operating hours of the units.

When selecting the logic of the addresses, the unit that is on with the highest address switches to Standby, and the unit in Standby with the highest address is started.

When selecting the logic of the operating hours, the unit that is on with the highest number operating hours switches to Standby, and the unit in Standby with the lowest number of operating hours is started.

22.1.4 Fixed day rotation

With the clock board (optional on pCO¹, pCO^{XS} standard on pCO² and pCO³) the time and every how many days (max. 7) can be set for performing the rotation of the units. The logic is the same as fixed time rotation, the only difference is that in this case the actual moment the rotation takes place can be set for a certain day and a certain time.

22.1.5 Rotation based on the operating hours

Rotation occurs between the units with the most operating hours and those with the least number of hours, switching the former to Standby and starting the latter. The reference operating hours for this type of rotation relate to the outlet fan; for more convenience these can be modified in the maintenance branch screens E6 and E7.

22.1.6 Master control

The units connected in the pLAN network and in Present / ... mode obey the operating logic of the unit with pLAN address 1 in "control" mode, for the purpose of having the entire installation operate with the same logic. This avoids the problem that may occur in large areas featuring zones with different temperature or humidity, in which the units with different logic each respond to their own probe, meaning some start humidification mode and others dehumidification, or some heating and others cooling, cancelling out their effect and wasting energy.

IMPORTANT: the temperature and humidity probes on the control unit must be placed in an "average" position inside the controlled environment.

The control unit sends the information on the logic to be adopted across the pLAN network, and then the units in the network base the activation of the devices both on the reading of their own probes, and on the order sent by the control unit, so that if the two things coincide the devices can start.

The control unit changes the operating logic if the temperature or the humidity measured exceed the set point by a few tenths. In the event of a blackout or disconnection of the control unit from the pLAN network, the units in the network return to independent operation and based only on their own probes.

23. Alarms

The alarms managed by the program are designed to protect the connected devices and provide signals if the control parameters are outside of the range of normal values or if there are faults on the board. The alarms may derive from the alarm digital inputs, from the probes or from the board. The effect of the alarms ranges from signal-only, to the shutting down of one or more devices, to the shutting down (OFF) of the air-conditioning unit. Many alarms feature modifiable delays.

When an alarm goes off, the following actions occur:

- the buzzer on the external terminal sounds (absent on the Built-in terminal and the external PGDO* terminal);
- the red LED under the ALARM button comes on;
- the message AL flashes on the Menu screen.

Pressing the Alarm button mutes the buzzer and displays the alarm screen. If there is more than one active alarm, once having entered the alarm menu, simply use the arrow buttons to scroll the alarms. Pressing any other button exits the alarm screen, however the events remain saved and are displayed again whenever the Alarm button is pressed.

To manually reset the alarms and delete the messages, simply enter the alarm screen and press the Alarm button again; if the cause of the alarms is no longer present (digital inputs reset or temperature returned to normal, etc...) the screen disappears, the red LED goes off and the message NO ACTIVE ALARMS is displayed. If the causes of one or more than one alarm are still present, only the alarms whose causes are no longer present are reset, while the others remain displayed and the buzzer and the red LED comes on again.

23.1 Alarm relay

The medium boards allow the possibility of having one relay for the serious alarms and one relay for the minor alarms. The small boards group all the alarms on the only relay available. The minor alarm relay is closed by any alarm; the serious alarm relay is closed only for serious alarms. Each alarm managed can be set as serious (Serious) or minor (Not Serious), thus determining which relay must be activated.

For both relays, the delay before closing can be set.

23.2 Alarm summary table

CODE	DESCRIPTION	DELAY	UNIT OFF	DEVICES OFF
AL01	General alarm compressor 1	-	-	Compressor 1
AL02	General alarm compressor 2	-	-	Compressor 2
AL03	Low pressure compressor 1	See T2	-	Compressor 1
AL04	Low pressure compressor 2	See T2	-	Compressor 2
AL05	No air flow	See T4	yes	All
AL06	Outlet fan overload	-	yes	All
AL07	Heater 1 thermal overload	-	-	Heater 1
AL08	Heater 2 thermal overload	-	-	Heater 2
AL09	Fire / Smoke detected	-	yes	All
AL10	Dirty filters	-	-	-
AL11	High room temperature	See T2	-	-
AL12	Low room temperature	See T2	-	-
AL13	High ambient humidity	See T2	-	-
AL14	Low ambient humidity	See T2	-	-
AL15	Operating hour threshold reached for compressor 1	-	-	-
AL16	Operating hour threshold reached for compressor 2	-	-	-
AL17	Operating hour threshold reached for outlet fan	-	-	-
AL18	Room temperature probe faulty or disconnected	60 s (fixed)	-	Compressors end valve

AL19	Recovery water temperature probe faulty or disconnected	60 s (fixed)	-	-
AL20	Outside air temperature probe faulty or disconnected	60 s (fixed)	-	-
AL21	Outlet air temperature probe faulty or disconnected	60 s (fixed)	-	-
AL22	Ambient humidity probe faulty or disconnected	60 s (fixed)	-	Humidifier/Dehumidifier
AL23	Condenser 1 pressure probe faulty or disconnected	60 s (fixed)	-	-
AL24	Condenser 2 pressure probe faulty or disconnected	60 s (fixed)	-	-
AL25	Condenser 1 temperature probe faulty or disconnected	60 s (fixed)	-	-
AL26	Condenser 2 temperature probe faulty or disconnected	60 s (fixed)	-	-
AL27	Built-in humidifier: high current	-	-	Humidifier
AL28	Built-in humidifier: no water in the cylinder	-	-	Humidifier
AL29	Built-in humidifier: low current	-	-	Humidifier
AL30	Clock board absent or not working	-	-	-
AL31	High pressure circuit 1	-	-	Compressor 1
AL32	High pressure circuit 2	-	-	Compressor 2
AL33	Water on the floor	-	yes	All
AL34	Auxiliary alarm	-	-	-
AL35	High pressure + compressor 1 thermal overload	-	-	Compressor 1
AL36	Operating hour threshold reached for humidifier	-	-	-
AL37	High pressure + compressor 2 thermal overload	-	-	Compressor 2
AL38	Condenser fan 1 thermal overload	-	-	Cond. fan 1
AL39	Condenser fan 2 thermal overload	-	-	Cond. fan 2
AL40	No water flow	See T4	yes	All
AL41	pLAN disconnected	60 s (fixed)	-	-
AL42	Driver 1 probe S1 faulty or disconnected alarm	See Fb	-	Compressor 1
AL43	Driver 1 EEPROM damaged	-	-	Compressor 1
AL44	Driver 1 valve motor faulty or damaged	-	-	Compressor 1
AL46	Driver 1 high evaporation pressure (MOP)	See Fa	-	Compressor 1
AL47	Driver 1 low evaporation pressure (LOP)	See Fa	-	Compressor 1
AL48	Driver 1 low superheat	See F9	-	Compressor 1
AL49	Driver 1 valve not closed during blackout	-	-	Compressor 1
AL50	Driver 1 high suction temperature	See F9	-	-
AL51	Driver 2 probe S1 faulty or disconnected alarm	See Fb	-	Compressor 2
AL52	Driver 2 EEPROM damaged	-	-	Compressor 2
AL53	Driver 2 valve motor faulty or damaged	-	-	Compressor 2
AL55	Driver 2 high evaporation pressure (MOP)	See Fj	-	Compressor 2
AL56	Driver 2 low evaporation pressure (LOP)	See Fa	-	Compressor 2
AL57	Driver 2 low superheat	See F9	-	Compressor 2
AL58	Driver 2 valve not closed during blackout	-	-	Compressor 2
AL59	Driver 2 high suction temperature	See F9	-	-
AL60	Built-in humidifier: high conductivity alarm	See threshold Gb: delay 1h	-	Humidifier
AL61	Built-in humidifier: high conductivity pre-alarm	See threshold Gb: delay 1h	-	-
AL62	Built-in humidifier: low steam production	-	-	Humidifier
AL63	Built-in humidifier: water drain alarm	-	-	Humidifier
AL64	Built-in humidifier: cylinder full alarm	-	-	Humidifier
AL65	Built-in humidifier: cylinder being depleted signal	-	-	-
AL66	Built-in humidifier: presence of foam	-	-	-
AL67	Built-in humidifier: cylinder depleted	-	-	-
AL68	Driver 1 LAN Disconnected	Start: 0 s (fixed) stable operation: 30 s (fixed)	-	Compressor 1
AL69	Driver 2 LAN Disconnected	Start: 0 s (fixed) stable operation: 30 s (fixed)	-	Compressor 2
AL70	Built-in humidifier: compulsory maintenance alarm Cylinder 1	-	-	Humidifier
AL71	Built-in humidifier: recommended maintenance signal Cylinder 1	-	-	Humidifier
AL72	Driver 1 probe S2 faulty or disconnected alarm	See Fb	-	Compressor 1
AL73	Driver 1 probe S3 faulty or disconnected alarm	See Fb	-	Compressor 1
AL74	Driver 1 configuration not complete	-	-	Compressor 1
AL75	Driver 2 probe S2 faulty or disconnected alarm	See Fb	-	Compressor 2
AL76	Driver 2 probe S3 faulty or disconnected alarm	See Fb	-	Compressor 2
AL77	Driver 2 configuration not complete	-	-	Compressor 2

24. Alarm log

The alarm log is used to save the operating status of the air-conditioning unit when the alarms are generated or at certain moments. Each record saved to the memory represents an event that can be displayed. The log is useful in troubleshooting any faults as it represents a “snapshot” of the installation at the moment the alarm was generated, and may suggest the possible causes and solutions of the faults. The program features two types of log, the BASIC log and the ADVANCED log.

24.1 Basic log

The significant memory space on the pCO boards allows the events to be stored. The BASIC log can be enabled with a parameter; if the clock board is not fitted (optional on the pCO¹ and pCO^{KS}, included on the pCO² and pCO³), the BASIC log is not available. No other optional boards are used.

A maximum number of 100 events can be saved; on reaching the one hundredth alarm, that is, the last space available in the memory, the next alarm overwrites the oldest alarm (001), which is thus deleted, and so on for the following events. The events saved can be deleted by parameter on screen V1 or by restoring the default values. The BASIC log screen can be accessed by pressing the ALARM button when screen A4 is displayed, and exited by pressing the MENU button (Esc when using the Built in terminal), and has the following layout:

```

                HISTORY_ALARMS
      +-----+
      |History alarm   H025|
      |                |
      |General al. compl|
      |12:30          15/08/06|
      +-----+
  
```

The following data are saved for each alarm, corresponding to the status of the air-conditioner when the alarm occurred:

- alarm description;
- time;
- date;
- chronological number of the event (0 to 100).

The chronological number of the event, shown in the top right corner, indicates the “age” of the event in the list of 100 events available. The alarm number 001 is the first event after the BASIC log was enabled, and therefore the oldest.

If the cursor is moved to the chronological number, the “history” of the alarms can be scrolled using the arrow buttons, from 0 to 100.

For example, from position 001 pressing the down arrow has no effect.

If 15 alarms have been saved and the log is in position 015, pressing the up arrow has no effect.

24.2 Advanced log

The events are saved to the 1MB or 2MB memory expansion, permanently connected to the board. The advantages and characteristics are listed below:

- Log by event: a typical log by event is the alarm log. If an alarm is activated, the alarm can be saved together with other significant values (temperature, pressure, set point, etc.).
- Log by time: a typical log by time is the log of temperature/pressure values. The temperature and pressure values are saved at regular intervals.
- Log of the logs: this saves the last alarms/temperature/pressure values recorded before a serious alarm. Unlike the data saved by the event and time logs, these data are not overwritten when the memory is full.
- Possibility to choose the values to be saved and the saving method at any time. The “WinLoad” program can be used to define the values to be saved and the saving method, using a practical “Wizard”. WinLoad does not need the application software “files”, as it can directly request the information required from the application software installed on the pCO.
- 1MB or 2MB dedicated flash memory. The system saves the data to the 1MB flash memory on the memory expansion. As an example, 1MB of memory can contain 5000 alarm events with 5 values for each alarm, and save 2 values, for example temperature and pressure, every 5 minutes for 6 months.
- Possibility to define up to 7 different log configurations. Typically each controller will have an alarm log configured, and a log of the control values (temperature/humidity/pressure) and some “logs of the logs”.
- Lookup the data saved from the LCD terminal (external or built-in) or from a connected PC.
- “Black box” operation. The memory expansion that contains the logs can be removed from the pCO on the controlled unit and inserted in another pCO to lookup the data saved. This pCO does not need to run the same software as the original.
- Reliability of the data saved. The data are saved to FLASH memory that does not require batteries that may discharge. If following a software update the previously saved data are incompatible with the new software, all the data will be deleted (following confirmation).

24.2.1 Configuration using “Winload”

The Advanced Log function, including all the options described above, is configured using the “On line help” feature in the WinLoad32 program, the same used to upload the program software to the pCO boards.

25. Supervisor

The unit can be connected to a local or remote supervisor or telemaintenance system. The accessories available for the pCO* boards include an optional RS485 serial communication interface, supplied separately from the pCO* board (for the installation of the optional serial communication boards, see the pCO* installation manual).

The software can manage the following supervisor protocols:

- CAREL
- Modbus
- LonWorks (using the special optional board)
- Trend (using the special optional board)
- BACnet (using an external gateway or PCO-WEB)

If the serial communication values are set correctly, such as the serial address and communication speed, the unit will send the parameters shown in the following table. Setting the serial identification number to 0 disables the serial supervisory system.

Below is the list of the variables that are managed by the supervisor.

25.1 Variable database

A specific communication database is featured that includes all the more important program variables, from the values read by the probes to the parameters set on the screens. The following table describes the database, divided into digital, integer and analogue variables, indicating for each its description, address and type, that is, read-only (R) or modifiable from the supervisor (R/W).

25.1.1 Digital variables

DESCRIPTION	SCR	ADD.	TYPE
Digital input number 1	I3	1	R
Digital input number 2	I3	2	R
Digital input number 3	I3	3	R
Digital input number 4	I4	4	R
Digital input number 5	I4	5	R
Digital input number 6	I4	6	R
Digital input number 7	I5	7	R
Digital input number 8	I5	8	R
Digital input number 9	I6	9	R
Digital input number 10	I6	10	R
Humidifier water level contact	I6	11	R
Digital input number 12	I7	12	R
Digital input number 13	I7	13	R
Digital input number 14	I7	14	R
Digital output number 1	Ib	15	R
Digital output number 2	Ib	16	R
Digital output number 3	Ib	17	R
Digital output number 4	Ic	18	R
Digital output number 5	Ic	19	R
Digital output number 6	Ic	20	R
Digital output number 7	Id	21	R
Digital output number 8	Id	22	R
Digital output number 9	Ie	23	R
Digital output number 10	Ie	24	R
Digital output number 11	Ie	25	R
Digital output number 12	If	26	R
Digital output number 13	If	27	R
General alarm compressor 1	A01	28	R
General alarm compressor 2	A02	29	R
Low pressure alarm compressor 1	A03	30	R
Low pressure alarm compressor 2	A04	31	R
Air flow alarm	A05	32	R
Fan thermal overload alarm	A06	33	R
Heater 1 overload alarm	A07	34	R
Heater 2 overload alarm	A08	35	R
Fire / smoke alarm	A09	36	R
Dirty filter alarm	A10	37	R
High room temperature alarm	A11	38	R
Low room temperature alarm	A12	39	R
High ambient humidity alarm	A13	40	R
Low ambient humidity alarm	A14	41	R
Operating hour threshold alarm, compressor 1	A15	42	R
Operating hour threshold alarm, compressor 2	A16	43	R
Fan operating hour threshold alarm	A17	44	R
Room temperature probe broken alarm	A18	45	R
Recovery temperature probe broken alarm	A19	46	R
Outside temperature probe broken alarm	A20	47	R
Outlet temperature probe broken alarm	A21	48	R

DESCRIPTION	SCR	ADD.	TYPE
Ambient humidity probe broken alarm	A22	49	R
Pressure probe 1 broken alarm	A23	50	R
Pressure probe2 broken alarm	A24	51	R
Cond. 1 temperature probe broken alarm	A25	52	R
Cond. 2 temperature probe broken alarm	A26	53	R
High current alarm in the humidifier	A27	54	R
Humidifier no water alarm	A28	55	R
Humidifier no current alarm	A29	56	R
Clock board broken alarm	A30	57	R
High pressure alarm circuit 1	A31	58	R
High pressure alarm circuit 2	A32	59	R
Flood alarm	A33	60	R
Auxiliary alarm	A34	61	R
Thermal overload and high pressure alarm, comp. 1	A35	62	R
Operating hour threshold alarm, humidifier	A36	63	R
Thermal overload and high pressure alarm, comp. 2	A37	64	R
Condenser fan 1 thermal overload alarm	A38	65	R
Condenser fan 1 thermal overload alarm	A39	66	R
Water flow alarm	A40	67	R
Enable compressors/cooling coil together with the recovery coil	G0	69	R/W
Enable outside temperature probe	Cm	70	R/W
Enable pressure probe 1	Cj	71	R/W
Enable pressure probe 2	Ck	72	R/W
Enable humidity probe	Ci	73	R/W
Enable outlet probe	Cl	74	R/W
Enable condenser 1 temp. probe	Cn	75	R/W
Enable condenser 2 temp. probe	Cn	76	R/W
Enable recovery probe	Cl	77	R/W
Configure modulating output 1 (0=rec. valve; 1=modulating fan)	Cc	78	R/W
Type of unit (0=ED; 1=CW)	C1	79	R/W
Configure modulating output 2 (0=recovery valve; 1=humidifier)	Cc	80	R/W
Configure digital input 1 (0=fire/smoke; 1=flood)	C6	81	R/W
Configure digital input 12 (0=fire/smoke; 1=flood)	C5	82	R/W
Enable modulating outlet fan	Cd	83	R/W
Heating mode (0=heaters; 1=heating coil)	C2- C3	84	R/W
Type of cooling coil valve (0=0 to 10 V; 1=3p)	C3	85	R/W
Type of heating coil valve (0=0 to 10 V; 1=3p)	C2- C3	86	R/W
Enable 0 to 10 V modulating humidifier output	Cb	87	R/W
Type of main coil CW unit (0=single; 1=double)	C3	88	R/W
Type of condenser (0=single coil; 1=separate coils)	Ce	89	R/W
Select type of fans (0=inverter; 1=steps)	Ce	90	R/W
Enable condenser function	Ce	91	R/W
Enable Prevent high press. function	Gk-Gl	92	R/W

Enable outlet limit function	Pa	93	R/W
Enable compensation function	P7	94	R/W
Enable cooling coil for dehum.	Cg	95	R/W
Enable recovery coil	Cd	96	R/W
Dehum. contact logic (0=NO; 1=NC)	Cg	97	R/W
Enable compressor FIFO rotation	G1	98	R/W
Enable compressor load steps	C2	99	R/W
Part load contact logic (0=NO; 1=NC)	G1	100	R/W
Type of temperature control (0=P; 1=P+I)	G1	101	R/W
Enable built-in humidifier	Cg	102	R/W
Enable CAREL Master Control	Gm	105	R/W
Enable force unit in pLAN	Gp	106	R/W
Enable ON/OFF time bands	K2	107	R/W
Enable temperature time bands	K2	108	R/W
Enable humidity time bands	K2	109	R/W
Enable unit shutdown from button	P5	110	R/W
Enable Remote ON/OFF dig. input	P5	111	R/W
Unit ON/OFF from supervisor	---	112	R/W
Configure digital output 7 (0=recovery valve; 1=minor alarms)	C7	113	R/W
Select temperature unit of measure	C0	114	R/W
Enable clock board (pCO ¹ pCO ²)	C0	115	R/W
Enable printer	C0	116	R/W

Confirm hour setting	K0	117	R/W
Confirm minute setting	K0	118	R/W
Confirm day setting	K0	119	R/W
Confirm month setting	K0	120	R/W
Confirm year setting	K0	121	R/W
Reset alarms from the supervisor	---	123	R/W
Driver 1 disconnected	A68	124	R/W
Driver 2 disconnected	A69	125	R/W
Cylinder maintenance mandatory	A70	126	R/W
Cylinder maintenance recommended	A71	127	R/W
High conductivity alarm	A60	128	R/W
High conductivity warning	A61	129	R/W
Humidifier low production	A62	130	R/W
Drain alarm humidifier	A63	131	R/W
Full cylinder alarm	A64	132	R/W
Cylinder pre-exhaustion	A65	133	R/W
Foam in the humidifier	A66	134	R/W
Cylinder exhausted	A67	135	R/W
Type of 0 to 10 V modulating output (pCO ^{XS} only)	Cb	138	R/W
Unit state (On/Off)	---	139	R
Unit in cooling mode	M1	140	R
Unit in heating mode	M1	141	R
Unit type (0=ED; 1=CW)	C1	142	R

25.1.2 Analogue variables

DESCRIPTION	SCR	ADD.	TYPE
Ambient humidity probe reading	I0-m0	1	R
Pressure probe 1 reading	I0	2	R
Pressure probe 2 reading	I0	3	R
Room temperature probe reading	I1-m0	4	R
Outlet air temperature probe reading	I1	5	R
Outside temperature probe reading	I1	6	R
Condensing temperature probe 1 reading	I2	7	R
Condensing temperature probe 2 reading	I2	8	R
Water recovery temperature probe reading	I2	9	R
Temperature set point	S1	10	R/W
Minimum limit of the temperature set point	P1	11	R/W
Maximum limit of temperature set point	P1	12	R/W
Humidity set point	S1	13	R/W
Minimum limit of the humidity set point	P2	14	R/W
Maximum limit of the humidity set point	P2	15	R/W
Temperature set point time band Z1	K6	16	R/W
Temperature set point time band Z2	K6	17	R/W
Temperature set point time band Z3	K7	18	R/W
Temperature set point time band Z4	K7	19	R/W
Humidity set point time band Z1	K8	20	R/W
Humidity set point time band Z2	K8	21	R/W
Humidity set point time band Z3	K9	22	R/W
Humidity set point time band Z4	K9	23	R/W
Temperature dead zone	P3	24	R/W
Cooling proportional band	P3	25	R/W
Heating proportional band	P3	26	R/W
Humidification proportional band	P4	27	R/W
Dehumidification proportional band	P4	28	R/W
Maximum temp. set compensation offset	P7	29	R/W
Outside temperature probe calibration	A9	30	R/W
Condensing pressure probe 1 calibration	A8	31	R/W
Condensing pressure probe 2 calibration	A8	32	R/W
Humidity probe calibration	A8	33	R/W
Room temperature probe calibration	A9	34	R/W
Outlet temperature probe calibration	A9	35	R/W
Condensing temperature probe 1 calibration	Aa	36	R/W
Condensing temperature probe 2 calibration	Aa	37	R/W
Recovery temperature probe calibration	Aa	38	R/W
Differential temp. to stop dehumidification	G9	39	R/W
Outlet air differential	Pa	40	R/W
Outside air differential for compensation	P7	41	R/W
High pressure alarm differential	Gg	42	R/W
Condensing pressure differential	Gh	43	R/W

DESCRIPTION	SCR	ADD.	TYPE
Condensing temperature differential	Gi	44	R/W
Max condenser fan speed	Gj	45	R/W
Min condenser fan speed	Gj	46	R/W
Condensing pressure set point	Gh	47	R/W
Condensing temperature set point	Gh	48	R/W
Differential to force unit for high temperature	Gr	49	R/W
Differential to force unit for low temperature	Gq	50	R/W
Offset to force unit for high temperature	Gr	51	R/W
Offset to force unit for low temperature	Gq	52	R/W
High room temperature alarm offset	P8	53	R/W
Low room temperature alarm offset	P8	54	R/W
High ambient humidity alarm offset	P9	55	R/W
Low ambient humidity alarm offset	P9	56	R/W
Maximum outlet fan speed	G7	57	R/W
Minimum outlet fan speed	G7	58	R/W
Maximum humidifier production	Ch	59	R/W
End point for opening modulating humidifier output	G8	60	R/W
Start point for opening mod. humidifier output	G8	61	R/W
Maximum humidity probe value	Ci	62	R/W
Minimum humidity probe value	Ci	63	R/W
Maximum pressure probe 1 value	Cj	64	R/W
Minimum pressure probe 1 value	Cj	65	R/W
Maximum pressure probe 2 value	Ck	66	R/W
Minimum pressure probe 2 value	Ck	67	R/W
Temp. offset to restart dehumidification	G9	68	R/W
Prevent differential (pressure)	Gh	69	R/W
Prevent differential (temperature)	Gi	70	R/W
Prevent set point (pressure)	Gh	71	R/W
Prevent set point (temperature)	Gi	72	R/W
Water recovery temperature set point	P6	73	R/W
High pressure alarm set point	Gg	74	R/W
Outlet air limit set point	Pa	75	R/W
Outside air set point for compensation	P7	76	R/W
Outlet fan speed in dehum.	G7	77	R/W
Current superheating value driver 1	Il	78	R
Evaporation temperature driver 1	Il-lm	79	R
Suction temperature driver 1	Il	80	R
Evaporation pressure driver 1	lm	81	R
Condensing temperature driver 1	lm	82	R
Current superheating value driver 2	lo	83	R
Evaporation temperature driver 2	lo-lp	84	R
Suction temperature driver 2	lo	85	R
Evaporation pressure driver 2	lp	86	R
Condensing temperature driver 2	lp	87	R

25.1.3 Integer variables

DESCRIPTION	SCR	ADD.	TYPE
-------------	-----	------	------

Analogue output 1		1	R
-------------------	--	---	---

Analogue output 2		2	R
Analogue output 3		3	R
Analogue output 4		4	R
Current hour		5	R
Current minutes		6	R
Day		7	R
Month		8	R
Year		9	R
Day of the week		10	R
Hour setting	K0	14	R/W
Minute setting	K0	15	R/W
Day setting	K0	16	R/W
Month setting	K0	17	R/W
Year setting	K0	18	R/W
Number of compressors	C2	20	R/W
Number of compressors for dehumidification	Cg	21	R/W
Select number of ON/OFF fans	Ce	22	R/W
Number of heaters	C2- C3	23	R/W
Input configuration probe 2 (0=cond. press.1; 1=cond. temp.1; 2=outlet temp.)	C9	24	R/W
Input configuration probe 3 (0=cond. press.2; 1=cond. temp.2; 2=recovery temp.)	Ca	25	R/W
Configuration of digital input 5 (0=flood; 1=filters; 2=fire/smoke)	C4	26	R/W
Type of humidity probe signal (2=0 to 1 V; 3=0-10 V; 4=current)	Ci	27	R/W
Type of pressure probe signal 1 (2=0 to 1 V; 3=0 to 10 V; 4=current)	Cj	28	R/W
Type of pressure probe signal 2 (2=0 to 1 V; 3=0 to 10 V; 4=current)	Ck	29	R/W
Type of condenser 1 T probe signal (0=NTC; 1=pt1000; 2=0...1V; 3=0...10V; 4=current)	Cn	30	R/W
Type of condenser 2 T probe signal (0=NTC; 1=pt1000; 2=0...1V; 3=0...10V; 4=current)	Cn	31	R/W
Type of outside temperature probe signal (0=NTC; 1=pt1000)	Cm	32	R/W
Type of recovery temperature probe signal (0=NTC; 1=pt1000)	Cm	33	R/W
Type of room temperature probe signal (0=NTC; 1=pt1000)	Cl	34	R/W
Type of outlet temperature probe signal (0=NTC; 1=pt1000)	Cl	35	R/W
Select refrigerant (0=Any gas; 1=R22; 2=134a; 3=404a; 4=407C; 5=410a; 6=R507c; 7=R290; 8=R600; 9=R600a; 10=R717; 11=R744; 12=R728; 13=R1270)	C1	36	R/W
Air flow switch alarm delay	T4	37	R/W
Outlet fan off delay	T0	38	R/W
Outlet fan start delay	T0	39	R/W
Delay in activating minor alarm relay no.7	T3	40	R/W
Delay in activating serious alarm relay no.8	T3	41	R/W
Water flow switch alarm delay	T4	42	R/W
Delay between starts of different compressors	T6	43	R/W
Heater start delay	T8	44	R/W
Low pressure alarm delay	T2	45	R/W
Integral time for P+I control	T1	46	R/W
Minimum compressor off time	T5	47	R/W
Minimum compressor on time	T5	48	R/W
Delay between compressor starts	T6	49	R/W
Part load activation delay	T7	50	R/W
3 point valve travel time	T1	51	R/W
High-low temperature-humidity alarm delay	T2	52	R/W
High conductivity pre-alarm threshold	Ge	53	R/W
High conductivity alarm threshold	Ge	54	R/W
Type of humidifier	Ch	55	R/W
Start hour for ON/OFF time band F1-1	K3	58	R/W
Start minutes for ON/OFF time band F1-1	K3	59	R/W
DESCRIPTION	SCR	ADD.	TYPE
End hour for ON/OFF time band F1-1	K3	60	R/W
End minutes for ON/OFF time band F1-1	K3	61	R/W
Start hour for ON/OFF time band F1-2	K3	62	R/W
Start minutes for ON/OFF time band F1-2	K3	63	R/W
End hour for ON/OFF time band F1-2	K3	64	R/W
End minutes for ON/OFF time band F1-2	K3	65	R/W
Start hour for ON/OFF time band F2	K4	66	R/W
Start minutes for ON/OFF time band F2	K4	67	R/W

End hour for ON/OFF time band F2	K4	68	R/W
End minutes for ON/OFF time band F2	K4	69	R/W
Start hour for temperature time band Z1	K6	70	R/W
Start minutes for temperature time band Z1	K6	71	R/W
Start hour for temperature time band Z2	K6	72	R/W
Start minutes for temperature time band Z2	K6	73	R/W
Start hour for temperature time band Z3	K7	74	R/W
Start minutes for temperature time band Z3	K7	75	R/W
Start hour for temperature time band Z4	K7	76	R/W
Start minutes for temperature time band Z4	K7	77	R/W
Start hour for humidity time band Z1	K8	78	R/W
Start minutes for humidity time band Z1	K8	79	R/W
Start hour for humidity time band Z2	K8	80	R/W
Start minutes for humidity time band Z2	K8	81	R/W
Start hour for humidity time band Z3	K9	82	R/W
Start minutes for humidity time band Z3	K9	83	R/W
Start hour for humidity time band Z4	K9	84	R/W
Start minutes for humidity time band Z4	K9	85	R/W
Select ON/OFF time bands Monday (0=F1; 1=F2; 2=F3; 3=F4)	K5	86	R/W
Select ON/OFF time bands Tuesday (0=F1; 1=F2; 2=F3; 3=F4)	K5	87	R/W
Select ON/OFF time bands Wednesday (0=F1; 1=F2; 2=F3; 3=F4)	K5	88	R/W
Select ON/OFF time bands Thursday (0=F1; 1=F2; 2=F3; 3=F4)	K5	89	R/W
Select ON/OFF time bands Friday (0=F1; 1=F2; 2=F3; 3=F4)	K5	90	R/W
Select ON/OFF time bands Saturday (0=F1; 1=F2; 2=F3; 3=F4)	K5	91	R/W
Select ON/OFF time bands Sunday (0=F1; 1=F2; 2=F3; 3=F4)	K5	92	R/W
Condenser fan speed-up time fans	Gh- Gi	93	R/W
Compressor 1 operating hour threshold	A7	94	R/W
Compressor 2 operating hour threshold	A7	95	R/W
Humidifier operating hour threshold	A7	96	R/W
Fan operating hour threshold	A7	97	R/W
Unit rotation mode in pLAN	Gn	98	R/W
Forcing delays for high room temp.	Gp	99	R/W
Forcing delays for low room temp.	Gp	100	R/W
Interval in days for automatic rotation	Go	101	R/W
Automatic unit rotation hours	Go	102	R/W
Automatic unit rotation minutes	Go	103	R/W
Number of units in Standby mode	Gn	105	R/W
Automatic rotation interval for units in pLAN	Gn	106	R/W
pLAN connection class board 1 (0=not present; 1=present/no rotation; 2=present/rotation)	Co	107	R/W
pLAN connection class board 2 (0=not present; 1=present/no rotation; 2=present/rotation)	Co	108	R/W
pLAN connection class board 3 (0=not present; 1=present/no rotation; 2=present/rotation)	Co	109	R/W
pLAN connection class board 4 (0=not present; 1=present/no rotation; 2=present/rotation)	Cp	110	R/W
pLAN connection class board 5 (0=not present; 1=present/no rotation; 2=present/rotation)	Cp	111	R/W
pLAN connection class board 6 (0=not present; 1=present/no rotation; 2=present/rotation)	Cp	112	R/W
pLAN connection class board 7 (0=not present; 1=present/no rotation; 2=present/rotation)	Cq	113	R/W
pLAN connection class board 8 (0=not present; 1=present/no rotation; 2=present/rotation)	Cq	114	R/W
Valve position driver 1	Ik	115	R
Valve position driver 2	In	116	R
Configuration of analogue input 1 (pCOXS only)	C8	117	R/W
Configuration of analogue input 2 (pCOXS only)	C9	118	R/W
pCO* size (17=Extra large N.C.; 13=Extra large N.O.; 12=Small; 11=Medium; 10=Large)	---	119	R
pCO* type (0/2=pCO2; 1=pCO1; 3=pCOC; 4=pCOxs; 5=pCO0EM; 6=---; 7=pCO3)	---	120	R
Application version (i.e.: 22 -> version 2.2)	A0	121	R

26. Glossary

- **Branch – loop:** series of screens that concern the same subject and that can be reached easily by simply pressing the arrow buttons; the branch is accessed by pressing one of the buttons on the terminal, which displays the first screen in the loop.
- **Buffer (memory):** memory on the board used to save the default values selected by CAREL for all the parameters. Permanent memory even when power is OFF.
- **Built-in:** display housed on the backbone of the pCO board.
- **Buzzer:** audible buzzer fitted on the external terminals; this sounds extendedly in the event of alarms or briefly if the limits for setting the parameters are exceeded. The built-in terminals do not have a buzzer.
- **Dead zone:** this defines a very small temperature zone between the set point and the proportional band, inside which the devices are not activated.
- **Default:** this term defines the values, for example the set point and the temperature proportional band, that are automatically used by the system without modifications made by the user.
- **Freecooling:** the action of introducing outside air into the environment by opening a damper, so as to provide cooling while saving energy.
- **Manual:** activation and deactivation of all the devices connected to the outputs on the board, from the special screens and with the unit OFF.
- **Outlet:** this is the air introduced into the environment by the air-conditioner.
- **Proportional band:** this defines a temperature zone of a few degrees around the set point, inside which the system manages the operation of the control devices.
- **Ramp:** this term defines the travel of a modulating valve, from 0% to 100%.
- **Range:** interval of values allowed for a parameter.
- **Return – intake:** air from the controlled environment, taken in by the air-conditioner.
- **Screen:** this defines the page that is shown on the display.
- **Set point:** this defines the desired temperature (or humidity) value; the system activates the heating or cooling devices until the temperature or humidity has reached the set point.
- **Sleep mode:** defines the unit OFF status when requested by the Master unit, in Automatic rotation mode.
- **Step:** this defines an area of the proportional band (temperature or humidity) inside which a device is started and at the same time defines the activation and deactivation values for the device.
- **3-point valve – modulating valve:** 3-point valve is a commonly used valve, activated by 2 relays, one for opening and one for closing; a modulating valve, on the other hand, is controlled by a 0 to 10 V signal and is more precise.
- **Upload:** this is the operation that copies the application software from the computer or the programming key, to the flash memory on the pCO board.

CAREL reserves the right to make modifications or changes to its products without prior notice.

CAREL

CAREL INDUSTRIES HQs

Via dell'Industria, 11 - 35020 Brugine - Padova (Italy)

Tel. (+39) 049.9716611 Fax (+39) 049.9716600

<http://www.carel.com> - e-mail: carel@carel.com

Agenzia:/ Agency:

Cod. +030221426 rel. 2.6 11/02/2016